

A Proposal for New
Presentations



MULTI PROJECTOR

User's Manual

MP-15E

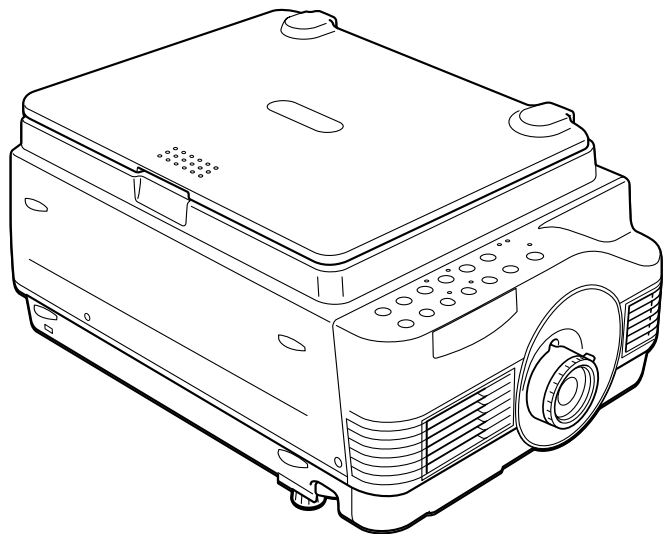

Thank you for purchasing the MP-15E Multi Projector.
Before operating your projector, please read this manual carefully.

● Features

- **5 in 1: The MP-15E offers five display functions from one machine.**
 1. Documents : Directly project documents, catalogs and other printed materials
 2. OHP : Selecting the OHP functions allow for direct viewing of transparencies, slides and other printed materials
 3. PC : Connect and display from your PC, Macintosh or other RGB equipment
 4. Video : Display images from VCRs, DVD and video cameras for enhanced multimedia presentations
 5. 3D Objects : Project 3D objects such as circuit boards, coins, lab objects
- **Ease of operation**

Easily switch between projecting printed materials to data or video images with a press of a button.
- **Total cost of ownership**

With direct access to the OHP, special transparencies are not required saving you time and expense.
- **Superb reproduction**

The MP-15E integrates a high-resolution single plate color CCD camera with 2 million pixels. This provides for realistic and sharp original color reproduction.
- **Image enlargement**

With Zoom capabilities, fine text and other material can be easily enlarged without moving the projector.
- **Image interpolation**

With native XGA resolution, the MP-15E is adept at projecting non-native sources up to SXGA and to VGA resolutions.

● About Trademarks

IBM is a registered trademark of IBM Corporation.
Macintosh and Power Book are trademarks of Apple Computer Inc.
Windows is a trademark of U.S. Microsoft Corporation.

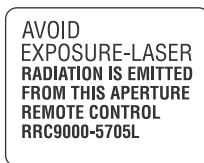
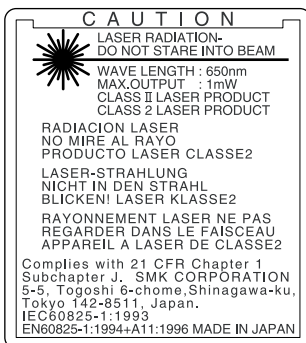

This label is located on the back of the remote control.

Do not look into the laser pointer while it is on and do not point the laser beam at another person. Serious injury could result.

Warnings and Safety Precautions

● Warning Symbols

To alert the user to important safety precautions, the following symbols are used in this manual and on the product. Make sure you understand what these symbols mean before reading this manual.



: Death or serious injury may result if this warning is ignored.



: Injury or damage to the equipment may result if this warning is ignored.



: This indicates an item that you should take care of when handling your multi projector.



: This symbol alerts the user to high voltage that may cause electric shock.

● Safety Precautions



• If a fault occurs:

- If you detect smoke, or a strange smell or sound, immediately pull out the power plug.
It is dangerous to continue using the projector after a fault occurs. Return the projector to the dealer where it was purchased for repair.

• Avoid placing the projector near dangerous substances.

- Make sure that no metallic or inflammable material can get into the projector through the air vents.
- Do not place any object containing water on top of or next to the projector.

• If foreign matter gets inside the projector:

- If foreign matter such as water or metal gets inside, immediately pull out the power plug.
It is dangerous to continue using the projector when foreign matter gets inside. Return the projector to the dealer where it was purchased for servicing.

• Do not remove the cabinet.

- Do not remove the cabinet. There are some high-voltage components inside and touching these parts may cause electric shock, or damage the equipment.

• Handle the power cable safely.

- Do not place any heavy object on top of the power cable.
Damage to the power cable can cause wire breakage, fire, or electric shock.
- Do not pull the power cable when disconnecting the power plug.
Pulling the cable may break the wires or cause fire or electric shock. Always hold the plug itself when pulling it out of the power point.
- Do not damage the power cable. If the power cable is damaged (e.g. the core is exposed or cut), contact the sales office of purchase.(charged)
It may cause fire or electric shock to continue using the damaged power cable.

-
- **Do not look through the lens.**
 - Do not look through the lens into the projector during operation.
The powerful rays passing through the lens may damage the eyes.
 - **Do not put the projector in unstable places.**
 - Do not put the projector in unstable places such as on unstable desks or slopes.
Doing so may cause the projector to drop or turn over, resulting in injury.
 - **Do not use any voltages other than specified.**
 - Do not use any voltages other than specified.
Doing so may cause fire or electric shock.
 - **Do not disassemble the alkaline batteries**
 - Do not short-circuit, disassemble, or burn the alkaline batteries.
Doing so may cause the leaked alkaline solution to enter eyes, or may result in fire, injury, or damages to the surrounding area due to heat or explosion.
If the alkaline solution touches skins or clothes, wash them with clean water.
If it get into eyes, immediately wash them with clean water and see a doctor.
 - **Do not bump the glass surface**
 - Do not bump the glass surface over the scanner.
Doing so may break the glass, resulting in injury.
 - **Do not touch the air vents or lamp cover**
 - The air vents, lamp cover, and peripheral surfaces may be hot during operation or just after the light is turned off.
Do not touch those for a long time.
 - **Do not block the lens front**
 - Do not block the lens front during operation.
The powerful rays passing through the lens may cause fire or burns if you put anything in front of the lens or block the lens with your hand during operation.

 **CAUTION**

- **Installation**
 - Avoid installing the projector in places where it may be exposed to:
 - Strong vibrations
 - Soot or steam
 - Direct sunlight or near a heater (35°C or higher)
 - High humidity or dust
 - Extreme cold (0°C or lower)
 - Strong magnetic or electric field generated from a nearby appliance
 - Wobbling on an unstable surface
- **Do not block the air vents.**
 - Do not block the air vents with cloth or an object.
When you put anything around the unit, be sure to ensure a space of 10 cm or more between the unit and the air vent. Be sure to prevent paper or cloth from blocking the air vent at the bottom of the unit. If blocked, the internal temperature may increase, resulting in malfunctions.
- **Do not bump the projector.**
 - Avoid bumping the projector when moving or handling.
Shocks can cause damage.
- **Care of the projector**
 - To prevent risk of accidents, always pull out the power plug before cleaning the projector.

-
- Clean the lens surface with a commercial blower or lens cleaning paper. Wiping with tissue paper or a handkerchief can damage the lens.
 - To clean the cabinet, operation panel, and glass surface, wipe gently with a soft cloth. For particularly dirty spots, soak the cloth in a neutral detergent mixed in water, wring out well and wipe off the dirt, then use a dry cloth to wipe dry.
 - Do not wipe the projector with any volatile solvent such as benzene or thinner. Solvents can cause surface deformation or flaking of the paint. If using an impregnated cloth, follow the instructions.
- **Avoid scratching the glass surface.**
 - Take care not to scratch the glass surface of the scanner with hard or pointed objects. Scratches on the glass may distort the projected image.
 - **Batteries**
 - When inserting batteries in the remote controller, note the poles (plus and minus signs) and insert correctly as indicated. Inserting a battery in a wrong direction can cause rupture or leakage, and may result in fire and injury or soil the surrounding area.
 - Do not use batteries other than the type specified for the equipment. Do not use a new battery and an old battery together. Incorrect battery usage may result in rupture or leakage, and may cause fire and injury.
 - Do not heat, break open, burn, or immerse the batteries. Battery rupture or leakage may cause fire and injury.
 - **Servicing and cleaning**
 - Have the internal components cleaned by a retailer about once a year. There is a risk of fire or faulty operation if the inside of the projector gets dusty and is not cleaned for a long time. For best effect, the projector should be serviced before the wet season brings damp conditions. Cleaning charges are at the discretion of the retailer.
 - **If not using the projector for a long period:**
 - If you do not plan to use the projector for a long time, pull out the power plug for safety.
 - **Disposal**
 - Follow the recommendations of your local authority when disposing of the projector.
 - **Transporting the projector**
 - Use the special packaging when transporting the projector. Nippon Avionics Co. Ltd. cannot accept responsibility in the event of damage or accident if other packaging is used.
 - Use the special packaging no more than two times. Repeated usage reduces the shock absorbency of the packaging and can lead to damage or accident.
 - Contact the retailer if you require new packaging.
 - **Lamp implosion**
 - An DC type New Super High pressure lamp is used in this projector and it is rare for the lamp to explode during use. The lamp is also designed to forcibly turn off because there is a high possibility that the lamp breaks if it is used beyond the lamp life of 1000 hours (Refer to pages 46 and 47).

Note the following things

- A noise occurs because the internal pressure of the New Super High pressure lamp gets extremely high. The unit is designed so that no pieces of glass come out of it when the lamp explodes.
- However, the gas inside of the lamp goes out and looks like white smoke, it will not lead to any fire.

Remedy

- The product whose lamp exploded has some small lamp pieces inside. Do not replace the lamp, but return it to the sales office or agent of purchase. Even though the lamp has exploded, never try to replace the lamp by yourself. The lamp pieces may cause injury.
- **Replacing the lamp**
 - Be sure to turn the lamp off and pull out the power plug when the fan stops, and wait an hour or more before start replacing the lamp. Replacing the lamp during operation or just after the power is turned off may cause burns due to heat. Refer to "Lamp Unit Replacement" on page 46 for the procedure.
- **Replacing / cleaning the air filter**
 - Be sure to pull out the power plug when the cooling fan stops before start removing the air filter. Removing the air filter while the cooling fan is rotating may cause burns injury. Refer to "Cleaning the Air Filter" on page 48 for the procedure.
- **Avoiding malfunctions and accidents**
 - Adjust the adjustable legs (Adjustable feet) to keep the projector horizontal. Using the projector in a tilted status may cause injury when it turns over. Refer to "Adjustable feet" on page 16 or the adjusting procedure.
- **Do not disassemble the manganese batteries**
 - Do not short-circuit, disassemble, or burn the manganese batteries. Doing so may cause the batteries to generate heat or explode due to the leaked solution, resulting in fire, injury, or damages to the surrounding area.
- **Do not do the followings**
 - Do not put anything heavy on the projector.
 - Do not step on the projector, rack, or stand. Do not hold or hang on the projector. Doing so may cause the projector to turn over or break, resulting in injury. Especially be careful if small kids are near.
 - Do not use the rack unless the casters are locked when placing the project on a rack with casters. Doing so may cause the projector to move or turn over, resulting in injury.
 - Do not turn the lamp on/off within one minute after it is turned off/on. Extremely high voltage is generated in the lamp just after it is turned on. Turning the lamp on/off too frequently may cause the lamp to deteriorate or break, resulting in malfunctions of the projector.
 - Do not project an image with the lens cap attached.
- **Moving the projector**
 - Be sure to pay attention to the glass surface when moving the projector while holding the handles with both hands.
 - If not inserted fully, the material cover may get loose off while you carry it.
- **Care of the power cable and plug**
 - Do not put the power cable near a heater. Doing so may cause the sheath of the cable to melt down, resulting in fire or electric shock.
 - Do not plug or pull out the power plug with wet hands. Doing so may cause electric shock.
 - Be sure to pull out the power plug and disconnect any cable connections between units and release the anti-theft lock before moving the projector. Moving the projector with cables attached may cause fire or electric shock because the cables are damaged.
 - If you do not plan to use the projector for a long time, pull out the power plug for safety.

● Notice

This equipment has been tested and found to comply with the limits for a Class A digital device, pursuant to Part 15 of the FCC Rules. These limits are designed to provide reasonable protection against harmful interference when the equipment is operated in a commercial environment. This equipment generates, uses and can radiate radio frequency energy and, if not installed and used in accordance with the instruction manual, may cause harmful interference to radio communications. Operation of this equipment in a residential area is likely to cause harmful interference in which case the user will be required to correct the interference at his own expense.

● FCC WARNING

Changes or modifications not expressly approved by the party responsible for compliance could void the user's authority to operate the equipment.

For FCC compatibility, use only cables specified by AVIO to connect to external devices.

● WARNING

This is a Class A product. In a domestic environment this product may cause radio interference in which case the user may be required to take adequate measures.

For EN55022 compatibility, use only cables specified by AVIO to connect to external devices.

Contents

Names and Functions of Each Section	9
Projector	9
Input Output Terminals	11
Buttons and Indicator Lights - Operation Panel -	12
Explanation of Buttons - Adjustment Panel -	13
Remote Controller	14
Remote Control Operations	15
Battery Replacement	15
How to Install the Projector	16
Installation sequence	16
Adjusting the Tilt	16
Projection Distance and Screen Size	17
Typical Installation	18
Connecting to a Personal Computer	19
Connecting to a Personal Computer	19
When Images on the Personal Computer Screen are not Projected	21
Input Signal Compatibility Table (PC video input)	22
Connecting to a Video Deck or Laser Disc Player	25
Basic Operation	26
Basic operation of PC or video input	26
When you have finished using the projector	28
Basic Operations in the OHP Mode	29
PC Zoom	32
Compensating Keystone	33
Performing Various Adjustments	34
Basic Operation	38
About the Memory Menu	42
Maintenance	44
Protection Against Overheating	44
Lamp Unit Replacement	46
Cleaning the Air Filter	48
Troubleshooting	49
Limited Warranty & Repair Service	50
LIMITED WARRANTY PERIOD	50
WARRANTY SERVICE PROCEDURE	50
Specifications	51

* Company names and product names herein are trademarks and registered trademarks of those companies.

Names and Functions of Each Section

Projector

Document Cover

The pickup section for documents and printed matter is located under this cover. See page 29.

Adjustment/Operation Panel

Buttons for setting adjustment menus and operating the projector are located here. Power ON/STANDBY, input selection, FREEZE, OHP zoom ratio, BRIGHTNESS, and other indicator LEDs are also located here. See pages 12 and 13.

Air Vent A2

Air is discharged from the inside to the outside through this vent.

Air Vent A3 (bottom of main unit)

Air is taken in through this vent.

Air Vent A1 (air filter)

Air is taken in through this vent. An air filter is provided to prevent dust from getting inside the projector. See page 48.

Anti-theft Lock

See the NOTE on the next page.

Adjustable Feet

These feet are for adjusting the tilt angle as well as the left and right balance of the projected image. Turning them counterclockwise raises the main unit, and turning them clockwise lowers the main unit. See page 16.

Tilt Adjustment Lever

Press this to adjust the adjustable feet. See page 16.

Lamp Unit Cover (bottom of main unit)

The projection lamp unit is housed inside this cover. See page 46.

Zoom Adjustment Ring

Turn this ring to adjust the screen size. See page 26.

Remote Control Sensor

Projection Lens

Images are projected through this lens.

Focus Adjustment Section

Turn this to adjust the focus. See page 27.

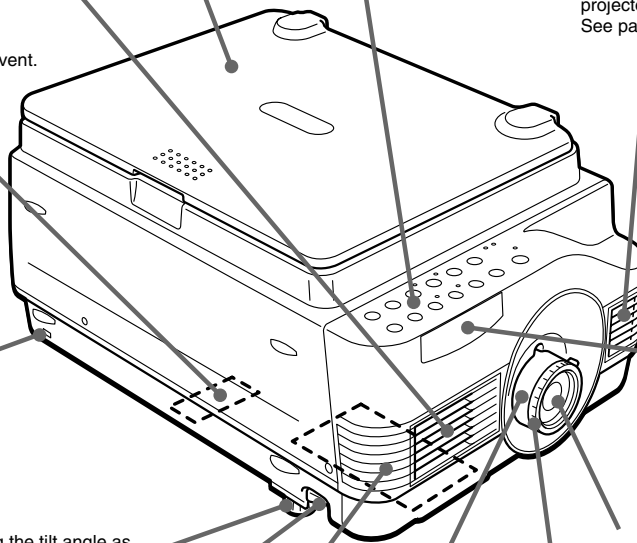

Document Pickup Section

Place documents or printed matter here to project images when OHP is selected.
See page 29.

Speakers

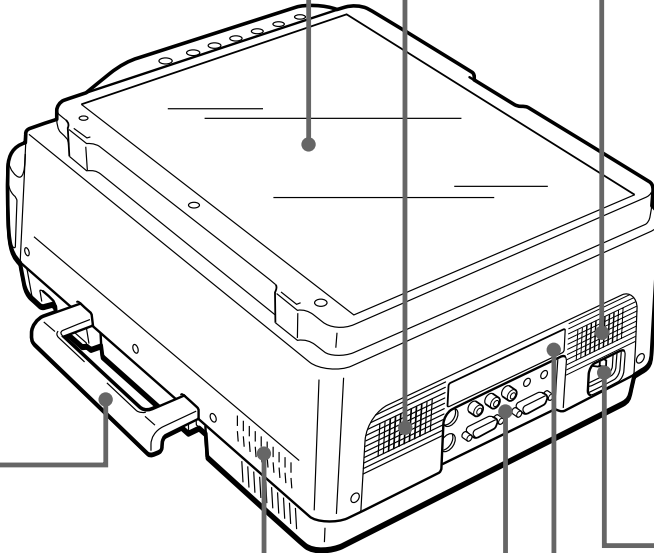

Handle

Air Vent B

Air is discharged from the inside to the outside through this vent.

I/O Terminal Section

Connection terminals for a PC or video deck are located here.
See page 11.

Power Input Terminal

Plug the power cord into this terminal.
See page 18.

Remote Control Sensor

NOTE

- About the anti-theft lock



*MicroSaver and Kensington are registered trademarks of Kensington Technology Group. All product names mentioned in this document are trademarks or registered trademarks of their respective owners.
© 1998 Kensington Technology Group.*

*Kensington Technology Group
2855 Campus Drive
San Mateo, CA 94403, U.S.A.*

*Phone:(650)572-2700
Fax:(650)572-9675*

Input Output Terminals

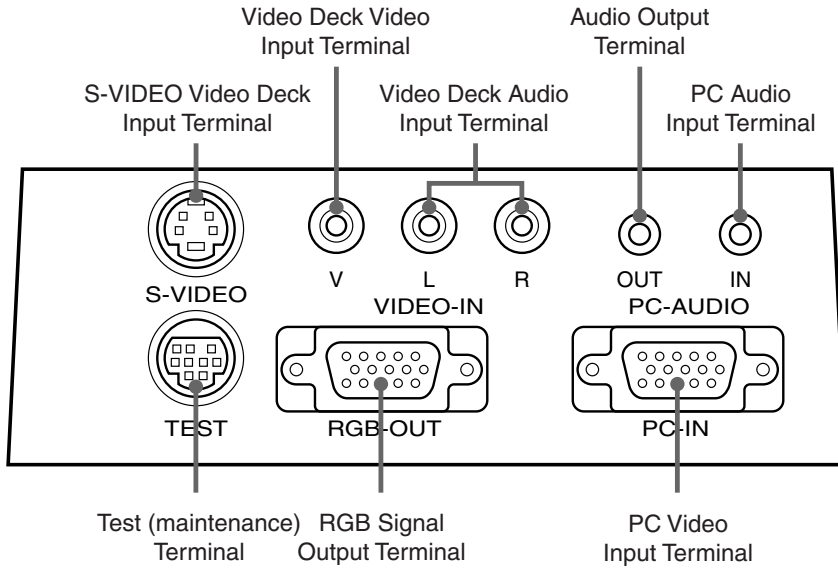

PC Video Input Terminal	Input terminal for the PC analog RGB signals
RGB Signal Output Terminal	When OHP is selected, OHP images are output. When PC/VIDEO is selected and during standby, input PC video is output as it is.
PC Audio Input Terminal	Audio input terminal for a PC (stereo compatible)
Video Deck Audio Input Terminals	Audio input terminals for a video deck (stereo compatible)
Video Deck Video Input Terminal	Input terminal for video deck (NTSC/PAL/SECAM)
S-VIDEO Input Terminal	Input terminal for video deck (Y/C)
Audio Output Terminal	Audio output terminal for MP-10 This terminal outputs audio (either from the PC or video deck) that is currently being input. In the standby mode, PC audio is output. When OHP input is selected, PC audio is output.
Test (maintenance) Terminal	This exclusive terminal is used when performing maintenance and in-house tests. It cannot be used for other connections.

■ Buttons and Indicator Lights - Operation Panel -

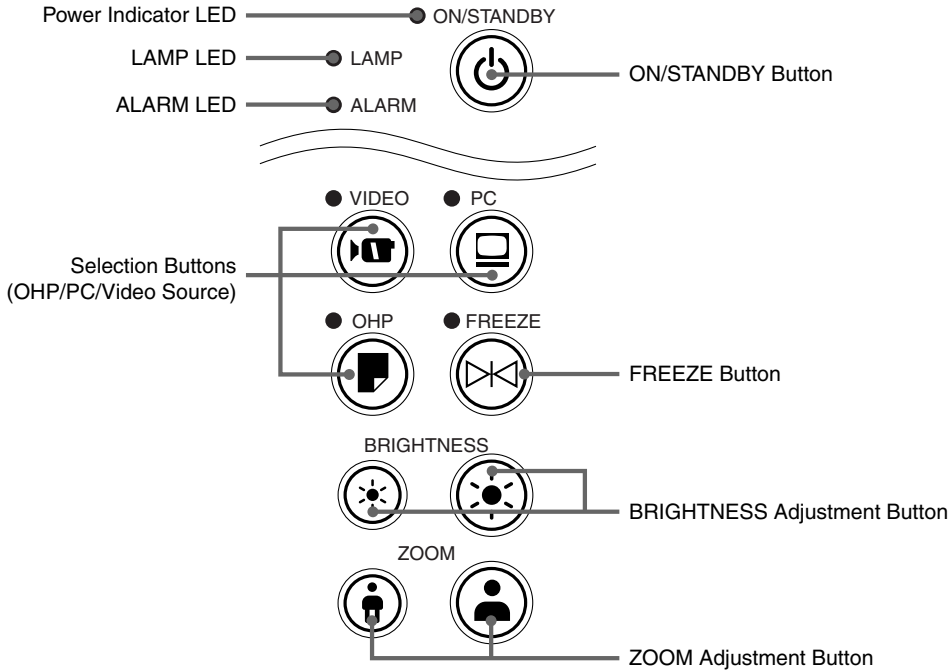

ON/STANDBY Button	<ul style="list-style-type: none"> • Press this button to turn the projection lamp on or off. • Only this button can be used when the projection lamp is off.
Selection Button (OHP/PC/Video Source)	<ul style="list-style-type: none"> • Press this button to switch the input screen. • When PC is selected, images from the PC input terminal are projected; when VIDEO is selected, images from the video deck input terminal are projected; or, when OHP is selected, an image of the printed matter or document placed on the pickup section on the main unit is projected.
ZOOM Adjustment Buttons (enabled only when OHP is selected)	<ul style="list-style-type: none"> • These buttons adjust the OHP zoom ratio. Pressing the left button reduces the image, and pressing the right button enlarges the image.
BRIGHTNESS Adjustment Buttons (enabled only when OHP is selected)	<ul style="list-style-type: none"> • These buttons adjust the OHP brightness. Pressing the left button darkens the screen, and pressing the right button lightens the screen.
FREEZE button	<ul style="list-style-type: none"> • When OHP is selected, this button freezes/unfreezes the projected image. This button cannot be used in the PC and VIDEO modes. • When the projected image is frozen, brightness cannot be adjusted. (Zoom can be adjusted and zooming position can be moved.)
Power Indicator LED	<ul style="list-style-type: none"> • This LED lights (red) in a standby state, and lights (green) when the lamp is lit. • This LED blinks (red) when the fan cover is open.
LAMP LED	<ul style="list-style-type: none"> • This LED lights while the lamp is lit. • This LED blinks for about six seconds and then lights during lighting operation (ON/STANDBY button "ON"). • This LED blinks for 120 seconds and then goes out during lamp out operation (ON/STANDBY button "STANDBY"). • This LED blinks when the lamp fails to light. (The LED blinking pattern in this case is faster than other instances.)
ALARM LED	<ul style="list-style-type: none"> • This LED blinks for ten seconds and lights when the temperature inside the projector has built up.

■ Explanation of Buttons - Adjustment Panel -

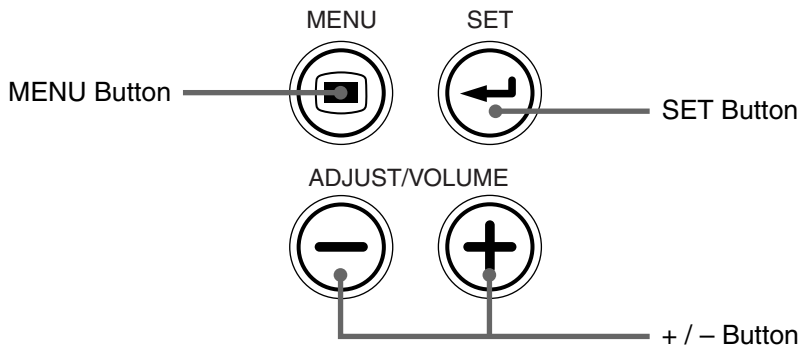

MENU Button	<ul style="list-style-type: none"> • Press this button to display the menu screen, or select menus. • For menu setting details, see page 34 onwards.
+ / - Button	<ul style="list-style-type: none"> • Press these buttons to select and adjust items selected by the MENU button. • This button can also be used to adjust the volume when the menu screen is not displayed.
SET Button	<ul style="list-style-type: none"> • Press this button to apply each menu item.

* Once menu screens or adjustment screens are displayed, their display automatically disappears, and adjustment values are stored to memory if buttons are not operated for about 15 seconds.

* **For details of menu adjustment, see page 34 onwards.**

Remote Controller

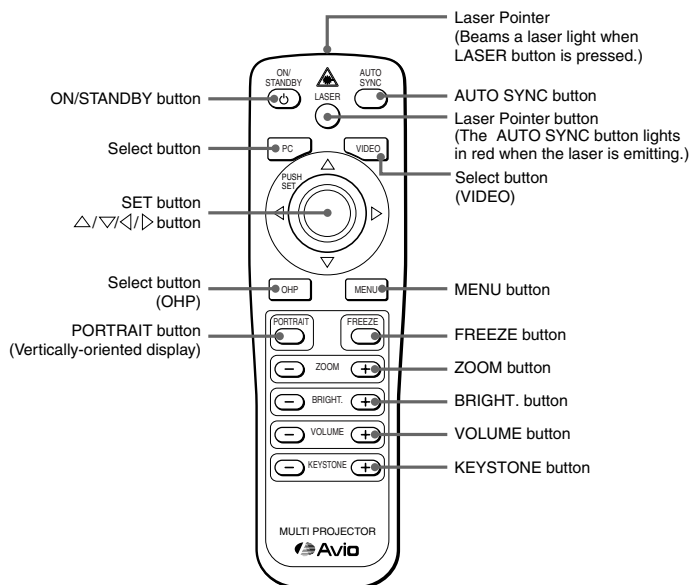

ON/STANDBY button	<ul style="list-style-type: none"> • Turns the projector lamp ON/OFF. • Only this button is valid when the projector lamp is turned OFF.
Laser Pointer button	<ul style="list-style-type: none"> • Laser Pointer button The laser is emitted from the front of the remote control while this button is pressed.
Select buttons (OHP/PC/VIDEO)	<ul style="list-style-type: none"> • Images from the PC INPUT connector are projected when PC is selected, images from the VIDEO INPUT when VIDEO is selected, and materials or printed matter placed on the projector are projected when OHP is selected.
MENU button	<ul style="list-style-type: none"> • This button shows the MENU display. • The same settings as from the operation panel are available using MENU items.
SET button	<ul style="list-style-type: none"> • Press to fix each menu item.
△/▽/◀/▶ buttons	<ul style="list-style-type: none"> • Use these buttons to change items, adjust values, or select items in the MENU display. • Scrolls the zoom screen in the zoom displays of the PC mode and OHP mode.
FREEZE button	<ul style="list-style-type: none"> • Freezes or cancels freezing of the display screen when OHP is selected. When the FREEZE button is activated, neither the PORTRAIT button nor the brightness adjustment button are operable. To perform these operations, first switch off the FREEZE button.
PORTRAIT button (Vertically-oriented display)	<ul style="list-style-type: none"> • Set the PORTRAIT display of the output screen or cancel it when OHP is selected.
ZOOM buttons	<ul style="list-style-type: none"> • These buttons adjust the OHP magnification in the OHP mode. • Adjusts the magnification of the PC in the PC mode. The left button reduces the image, while the right button enlarges the image.
Brightness control buttons	<ul style="list-style-type: none"> • These buttons adjust the OHP brightness. The left button makes the image darker, while the right button makes the image brighter.
Volume control buttons	<ul style="list-style-type: none"> • These buttons adjust the volume in the PC and the VIDEO modes. The left button turns down the volume, while the right button turns up the volume.
AUTO SYNC button	<ul style="list-style-type: none"> • This button performs synchronizing automatically. (Valid when PC/VIDEO is selected.)
KEY STONE button	<ul style="list-style-type: none"> • These buttons compensate keystoneing.

Remote Control Operations

- Use the remote controller within about 6 meters(6.5 yd) from the remote control sensors (on the front and rear sides) and within 30 degrees to the left and right. This distance may become shorter as the battery wears down.
- The remote controller does not work if there are obstacles between the remote controller and the remote sensor on the main unit.

Pay attention to the following when using the laser pointer:

- Do not look into the laser light.
- Do not point the laser light at people.
- Do not let children use the laser pointer.

Battery Replacement

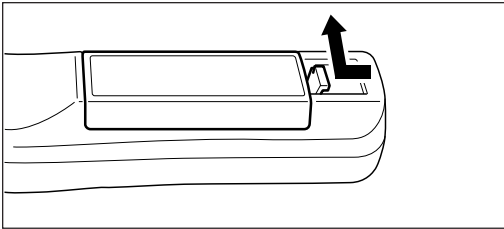

1. Push up while pulling on the tab of the cover.

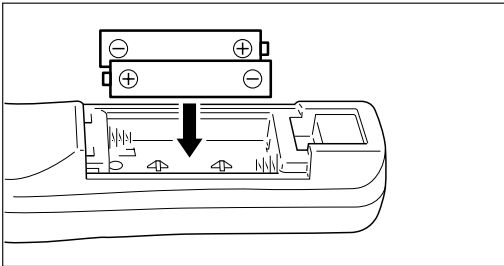

2. Install two batteries in the battery compartment, making sure that they are aligned as indicated by the (+) and (-) marks.

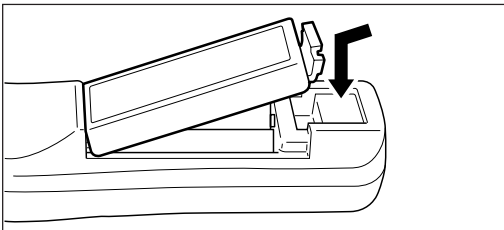

3. Slide the cover into position on the battery compartment.

CAUTION

Handling the remote controller

- Do not subject the remote controller to strong impact shock.
- Keep the remote controller away from water. Wipe the remote controller immediately if it gets wet.
- Avoid heat or hot water. Remove the dry cells when you are not using the remote controller for a long period of time.
- Do not mix new and old dry cells, or use different types of dry cells at the same time.
- Do not disassemble or heat batteries, or throw them into a fire.
- Follow your local government's disposal instructions for used dry cells.
- The remote controller may not work when it is used near inverter-driven equipment.
- The remote controller may not work or may work ineffectively when it is used near inverter-driven fluorescent lighting.

NOTE

- When replacing the battery, buy AAA batteries.
- Ni-Cad batteries or other chargeable batteries cannot be used. Use manganese batteries or alkaline batteries.

How to Install the Projector

Installation sequence

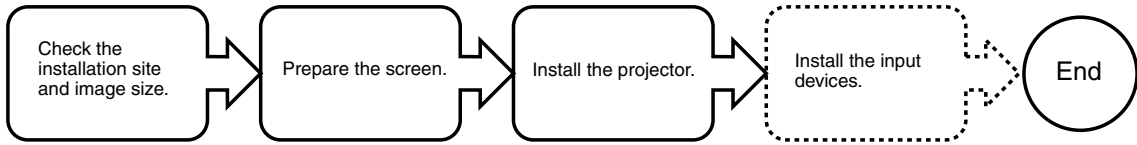

See "Projection Distance and Screen Size" on page 17.

PC, video deck, etc.

Adjusting the Tilt

The position and tilt angle of the projected screen can be adjusted by adjusting the adjustable feet.

Press both the left and right tilt adjustment levers to lift the main unit, and release them when the desired height is reached.

You can fine-adjust the tilt by turning the bottom section of the adjustable feet. Turning this section counterclockwise raises the main unit, and turning it clockwise lowers the main unit.

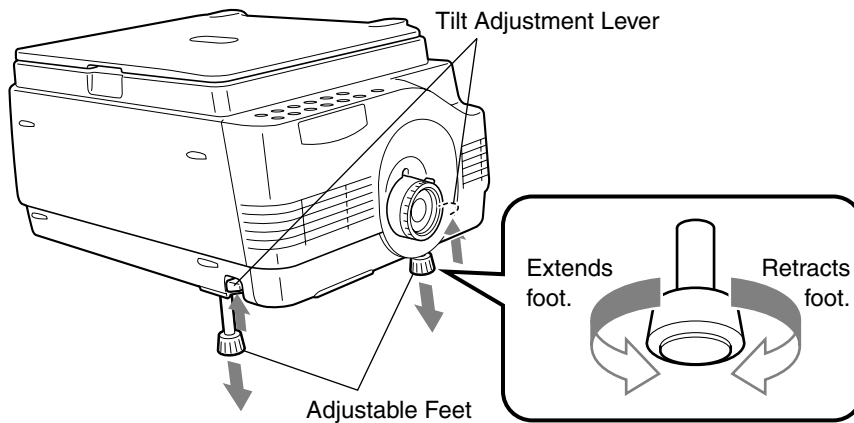

CAUTION

- Do not tilt the main unit at extreme angles by turning only one side of the adjustable feet. Doing so may cause the main unit to slip or fall down, resulting in accidents or failures.
- Vent A1 takes in air to cool the inside of the projector. As air is taken in by large suction force, cloth or paper may be sucked in against the vent. If this happens, the temperature inside may build up, and cause accident or failure.
- The rubber feet may soil the installation surface depending on where the projector is installed.

■ Projection Distance and Screen Size

Use the following diagrams to determine the screen display size and the type of screen required for any given projector location.

- The projection distance that provides good focusing is 1.15 m (1.2 yd) to 10 m (11 yd) from the front of the lens. Install the projector within this range.

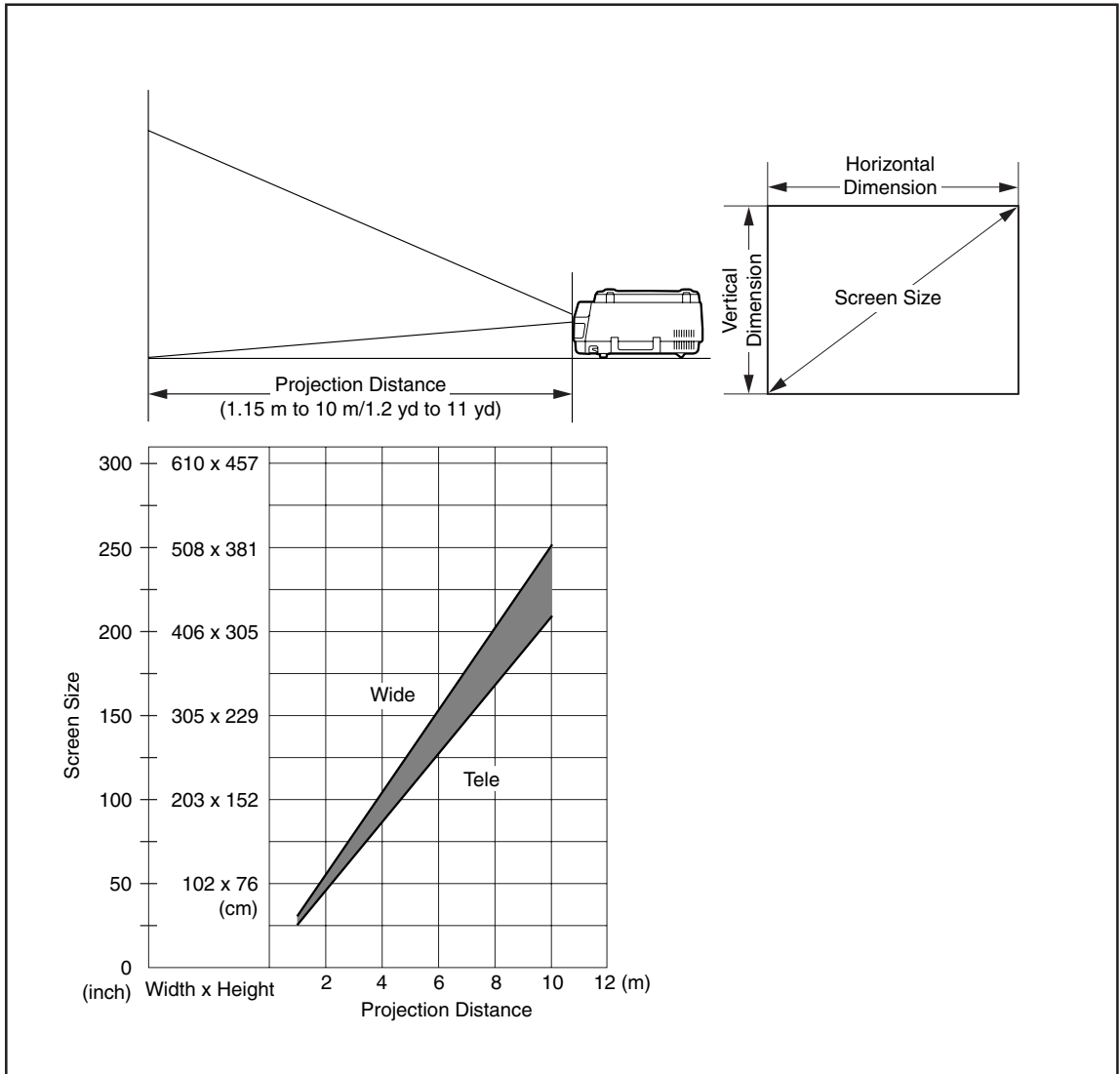

⚠ CAUTION

Installation location

- Do not install the projector at excessively hot or cold locations. The ambient temperature should be within 0°C to 35°C (32°F to 95°F).
- Position the projector so that the screen does not directly receive sunlight or other light from other lighting. Otherwise, the screen becomes white and is difficult to view.
In a bright room, use a curtain or other means to darken the area around the screen.
- Do not install the projector where it will be subject to excessive humidity, dust, or cigarette smoke. Otherwise, image quality may deteriorate as dirt builds up on the lens, mirrors and other optical components.
- Do not install the projector in a small room with poor air circulation or any place where the air vents may be blocked. Temperature build-up inside the projector may result in fire or a failure. (Vents are located at the front, right and bottom of the projector.)

■ Typical Installation

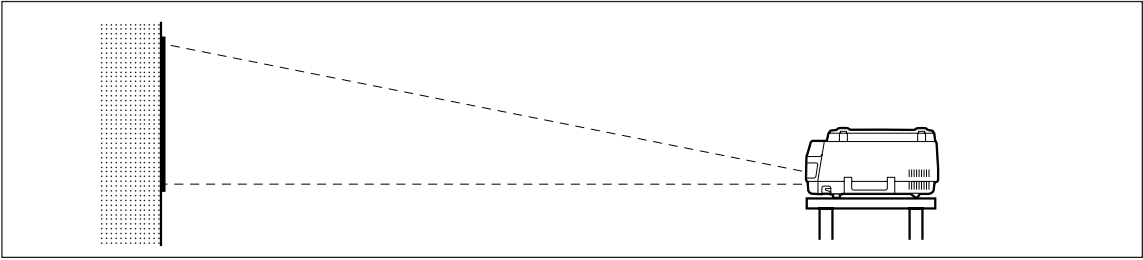

1. Select the installation site

Place the projector on an even and stable surface such as a table.

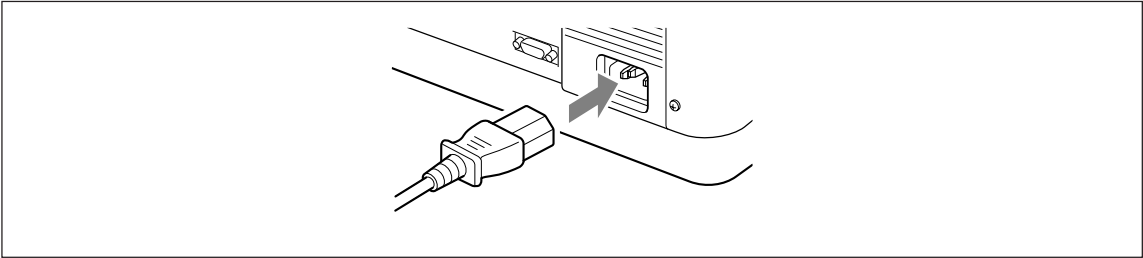

2. Connect the power cord (supplied), and press the () button (or button.)

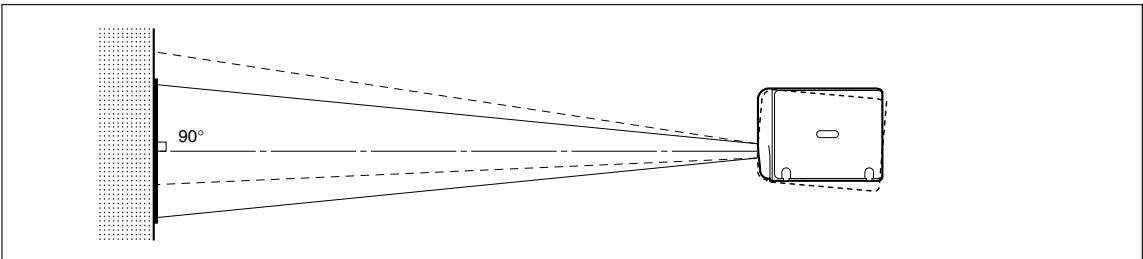

3. Turn the direction of the lens so that it is perpendicular to the screen.

Turn the unit to the left or right so that the top and bottom lines of the screen are parallel.

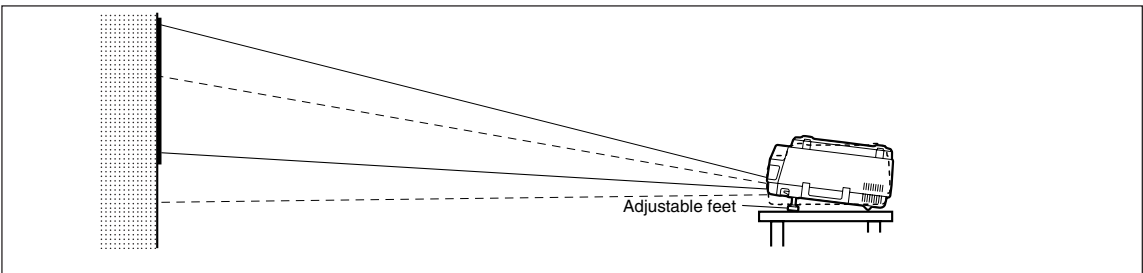

4. Adjust the adjustable feet to move the projected image to the desired height. (Adjust the tilt angle between 0° to 7°.)

The position of the projected image can be moved up or down by adjusting tilt.

Connecting to a Personal Computer

CAUTION

- To protect your projector and external input devices, make sure that all power supplies connected to these devices are turned OFF.
- For details of how to use and connect external input devices to be connected to your projector, refer to the user's manuals accompanying them.
- Sometimes images are not displayed properly when displaying on notebook PC LCDs. If this happens, turn the notebook PC display OFF. How to turn the notebook PC display OFF varies according to the manufacturer of the notebook. For details, refer to the User's Manual provided with the notebook PC.
- Some computers or computers in some settings cannot be connected to your projector. Please consult your dealer for details.

■ Connecting to a Personal Computer

● List of cables and adaptors

Maker	Type	RGB output Model	Connection
PC/AT compatibles	Notebook, Desktop type	Mini D-SUB 15-pin (VGA) Each maker	Supplied cable
Apple Macintosh	Notebook type	PowerBook, G3. (The monitor output needs to be mini D-SUB 15-pin.)	Supplied cable
		PowerBook (excluding iBook, DUO, 100, 140, 145B, 150, 170, etc.)	Adaptor (on the market) *+ Macintosh pin adaptor (on the market) Supplied cable
		PowerBook DUO	Adaptor (on the market) *+ Macintosh pin adaptor (on the market) Supplied cable
		* Cannot be connected to models without monitor output such as iBook, PowerBook 100, 140, 145B, 150, 170, etc.	* DUO Dock or Mini Dock is necessary.
	Desktop type	G3, G4 (The monitor output needs to be mini D-SUB 15-pin.)	Supplied cable
		Each model (excluding monitor-integrated type)	Adaptor + Supplied cable
		* The monitor-integrated type such as iMac, Classic, or certain Performa, etc. cannot be connected because they do not have a monitor output.	* When using the monitor that comes with the PC, a conversion adaptor for monitor is necessary. * The display adaptor (Apple make) is necessary to Power Mac 6100.

* Adaptor (on the market): Adaptor for PowerBook exclusively (Apple make: Power Book Video Adapter Cable M3927LL/A or third party make). In some cases, it comes with the Power Book.

About the PC Input and Output Terminals

15-pin mini D-Sub connectors are used for the PC input and output terminals.

The following shows the relationship between the pins and the input and output signals.

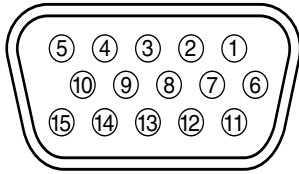

① RED VIDEO	⑥ GND	⑪ GND
② GREEN VIDEO	⑦ GND	⑫ ----
③ BLUE VIDEO	⑧ GND	⑬ H.SYNC
④ GND	⑨ ----	⑭ V.SYNC
⑤ ----	⑩ GND	⑮ ----

NOTE

- This projector uses a 15-pin RGB input and an analog type output terminals. For this reason, it cannot be connected to a digital output type personal computer.

■ If images of a personal computer are not projected

Check the following if images of a personal computer are not projected, or projected incorrectly.

● If images are not projected

If the external output signals from a personal computer are not input to MP-15E, “No PC signal” appears on the MP-15E display. Check the following if “No PC signal” appears.

1 Restart the computer.

The connection of MP-15E may not be recognized by the personal computer, if MP-15E is connected after the PC is started up. If the connection is not recognized, images are not projected because no external output signals from the PC are output.

2 Check the functions of the personal computer.

Some notebook PCs require a special operation to output the signals from the external output terminal. The external output signals may not be output from the notebook PC unless the operation is performed.

Refer to the manuals of your notebook PC for the information about how to output signals from the external output terminal.

Procedure example

- In the case of IBM PC/AT

Press (Fn) key and one of the keys (F1) - (F12) (Procedure may vary from models to models.)

○ List of countermeasures when the connection with the PC is defective

Maker	Series	Method to switch to external output
IBM	Think Pad	Fn+f7
COMPAQ	CONTURA ARMADA	Fn+f4
DELL	LATITUDE	Fn+f8

* This list is compiled based on the troubles that have occurred so far, so it does not include all kinds of connections.

* The company names, product names are the trade marks or registered trade marks of each company.

● Images are not projected correctly though they are displayed normally on the notebook PC.

1 Check the function of the notebook PC.

There is a possibility that images are not projected correctly even through the images are displayed correctly on the LCD of the notebook PC. When images are displayed on two or more devices at the same time (e.g. images on the LCD and the signals are output to other devices at the same time), the input signals are outside the scanning frequency range of MP-15E because of the restrictions on the notebook PC.

In this case, the correct images cannot be obtained even by the adjustment of MP-15E. Terminating the display on the LCD, so that only the external output signals are output, may project images correctly on MP-15E. Refer to the manuals of your notebook PC for details.

■ Input Signal Compatibility Table (PC video input)

The MP-15E supports the signals marked by ● in the following table. Note that on some PC models, flickering and blurring occur in the projected image. If this happens, adjust the screen in the Sync Adjustment menu.

Signal Name	Resolution (Horizontal × Vertical)		Horizontal Frequency (kHz)	Vertical Frequency (Hz)	Compatibility
NTSC RGB	-	-	15.7	60	×
PAL/SECAM RGB	-	-	15.6	50	×
VGA-GR1	640	480	31.5	60	●
VGA-GR2	640	400	31.5	70	●
VGA-GR3	640	350	31.5	70	●
VGA-TX1	720	400	31.5	70	●
VGA-TX2	720	350	31.5	70	●
640×480 72Hz	640	480	37.8	72	●
640×480 75Hz	640	480	37.5	75	●
640×480 85Hz	640	480	43.2	85	●
Mac13"RGB	640	480	35.0	66	●
800×600 56Hz	800	600	35.1	56	●
800×600 60Hz	800	600	37.8	60	●
800×600 72Hz	800	600	48.0	72	●
800×600 75Hz	800	600	46.8	75	●
Mac16"RGB	832	624	49.7	74	●
1024×768 43Hz	1024	768	35.5	43	×
1024×768 60Hz	1024	768	48.3	60	●
1024×768 70Hz	1024	768	56.4	70	●
1024×768 75Hz	1024	768	60.0	75	●
1024×768 85Hz	1024	768	68.7	85	●
MAC19"1024×768	1024	768	60.2	75	●
MAC21"1152×864	1152	864	68.7	75	●
1280×960 60Hz	1280	960	60.0	60	●
1280×960 85Hz	1280	960	85.9	85	●
1280×1024 60Hz	1280	1024	64.0	60	●
1280×1024 75Hz	1280	1024	80.0	75	●
1280×1024 85Hz	1280	1024	91.1	85	●
1600×1200 60Hz	1600	1200	75.0	60	×
1600×1200 65Hz	1600	1200	81.3	65	×
1600×1200 70Hz	1600	1200	87.5	70	×
1600×1200 75Hz	1600	1200	93.8	75	×
1600×1200 85Hz	1600	1200	106.3	85	×

* When the input signal resolution is lower than 1024 x 768 dots, enlarge the display. When it is higher, compress the display.

● Basic Connections

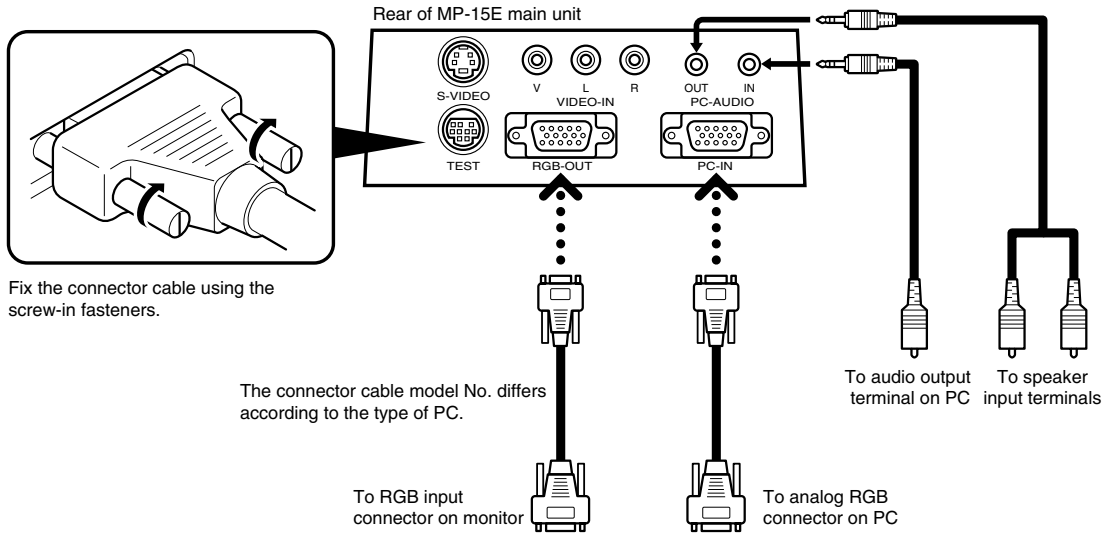

● Connecting to IBM NOTE and Compatible (DOS/V)

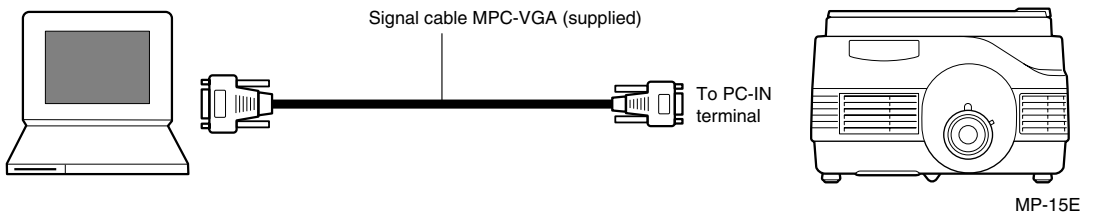

NOTE

After you have connected the MPC-VGA cable, check the external CRT output/internal LCD output states and set the mode in the software running on the PC.
The connection with the PC will not be made if you do not set the external CRT output mode.

● Connecting to an IBM Desktop and Compatible (DOS/V)

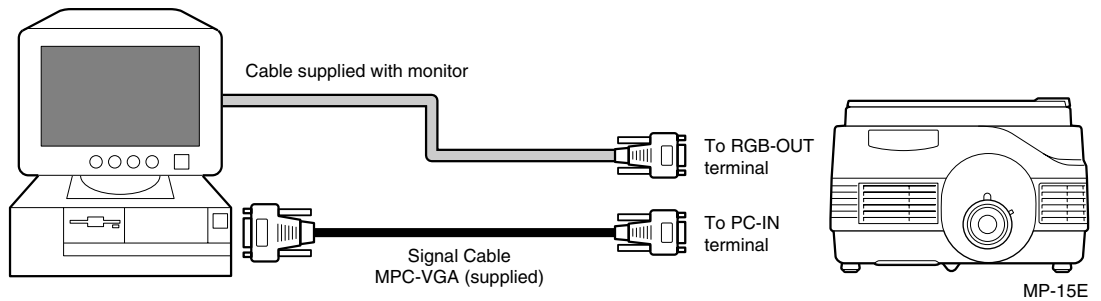

NOTE

• When connecting the projector directly to the PC without using the monitor supplied with the PC, you can connect by the MPC-VGA cable only.

● Connecting to Apple Macintosh Notebook

Excluding Power Book Duo, 100, 140, 145B, 150, 170

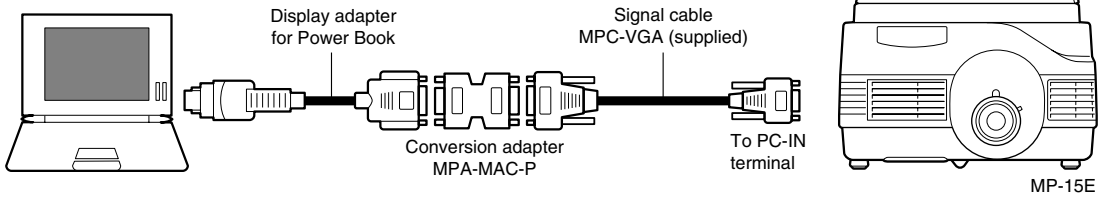

NOTE

- When connecting the Power Book Duo, the Duo Dock or Mini Dock is required.
- The Power Book display adapter is sometimes not supplied with the Power Book. If it is not supplied, buy a separate display adapter from a Macintosh computer store. (Apple M3927LL/A or equivalent)

● Connecting to Apple Macintosh Desktop

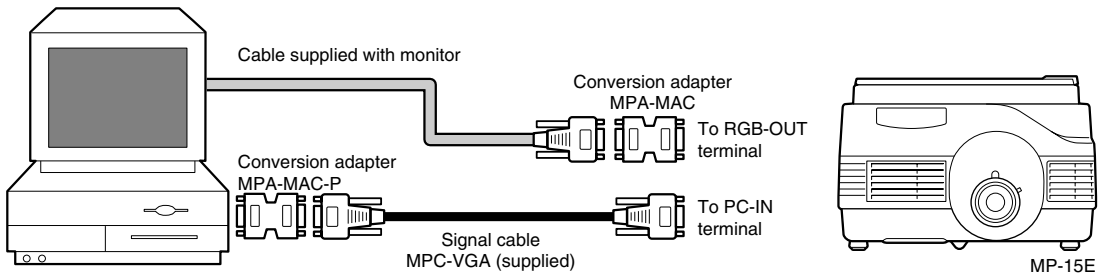

NOTE

- When connecting the projector directly to the Macintosh without using the monitor supplied with the Macintosh, you can connect by the MPC-MAC cable only.
- When connecting the Power Mac 6100, the Power Mac display adapter (M2681LL/A) is required.
- The projector cannot be connected to iMac or iBook.

■ Connecting to a Video Deck or Laser Disc Player

Images from a video deck or laser disk player can be projected on the large screen.

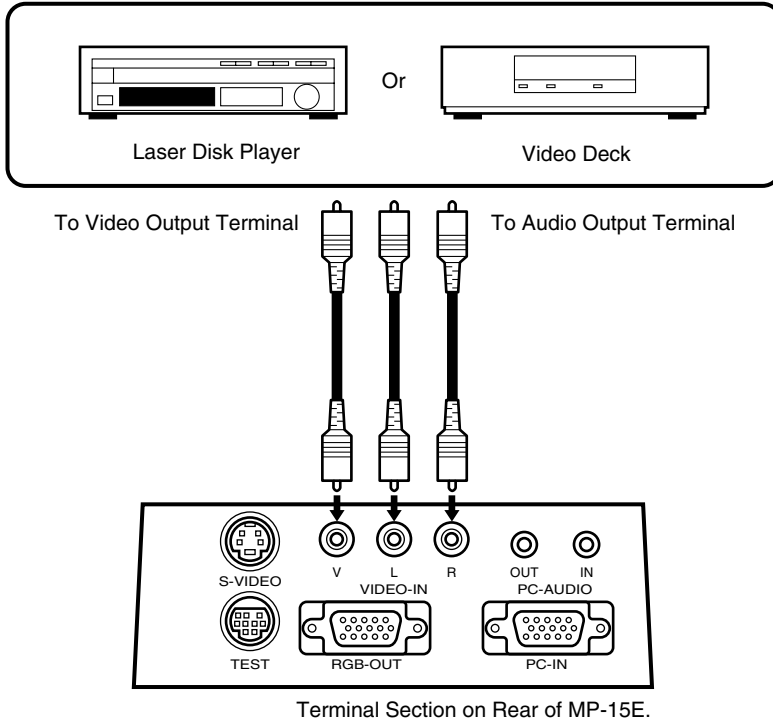

NOTE

- When both VIDEO and S-VIDEO are connected, S-VIDEO is given higher display priority.
- Before using the video deck or laser disk player, close the document cover. (Otherwise, the glass on the document pickup section may vibrate and cause a rattling sound.)

Basic Operation

Basic operation of PC or video input

Preparation: Turn connected devices on.

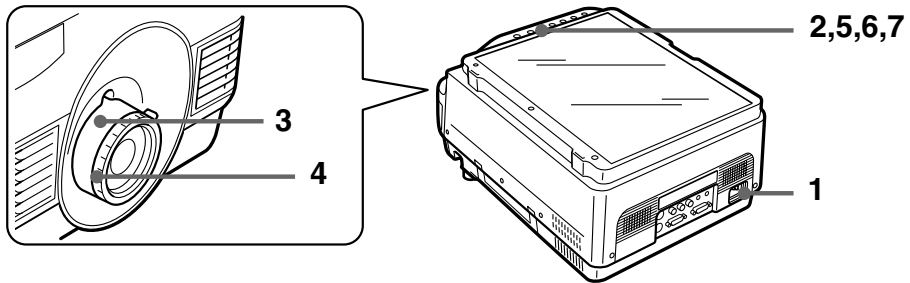

1

Connect the power cord.

The projector is in the standby mode, and the power indicator LED lights (red).



Press the ON/STANDBY button.

The LED lights, and the power indicator LED lights (green).
The LAMP LED lights (green).
If the LED lights (red) and starts blinking, see page 49.

● ON/STANDBY

○ LAMP

○ ALARM

2

Main Unit Operation

- VIDEO ● PC
- OHP

Remote Control Operation

- PC VIDEO
- OHP

NOTE

When PC/video is selected and the device is not connected, or the connected device is not turned on, a blue display appears and "No input" is displayed.

Select the external input device.

Select the video source to be displayed from OHP/PC/video deck.

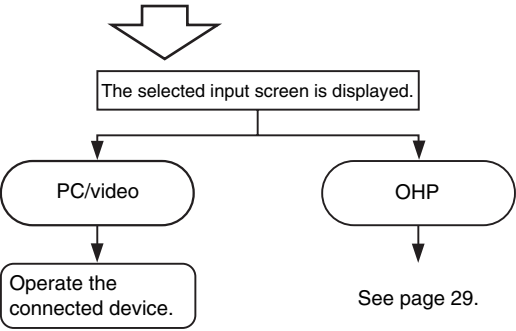

```
graph TD; A[The selected input screen is displayed.] --> B(PC/video); A --> C(OHP); B --> D(Operate the connected device.); C --> E(See page 29.);
```

3

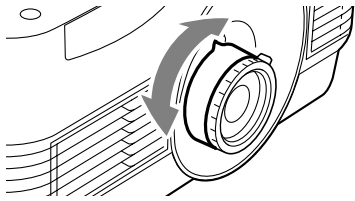

Adjust the zoom.

Adjust the screen size by turning the zoom adjustment ring on the projector lens.

4

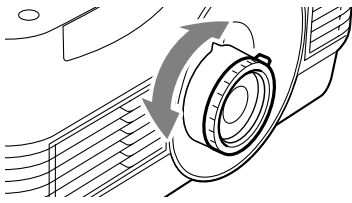

Adjust the focus.

Adjust the focus ring on the projection lens until the projected image is sharp.

5

Remote Control Operation



Compensate keystone.

See "Compensating Keystone" on page 33.

6

Remote Control Operation

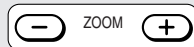

Adjust the PC zoom.

See "PC Zoom" on page 32.

7

Remote Control Operation



Adjust the volume.

When You Have Finished Using the Projector

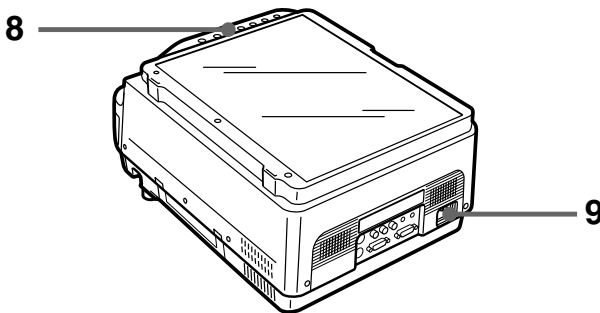

8

Main Unit Operation

ON/STANDBY



Remote Control Operation

ON/
STANDBY



NOTE

For one minute after the lamp lights, the lamp will not go out even if the ON/STANDBY button is pressed. At this time, "Cannot light for one minute." is displayed.

Turn the lamp off.

Press the ON/STANDBY button. (Hold down for at least one second.)



"Press ON/STANDBY again to turn off." is displayed on the projection screen.



Press the ON/STANDBY button again.

The LAMP LED blinks (green), and goes out after about 120 seconds.

The power indicator LED lights (red).

9

ON/STANDBY

LAMP

ALARM

Disconnect the power cord.

The power indicator LED on the operation panel goes out.

CAUTION

- Do not disconnect the power cord before turning off the lamp or before the lamp LED goes out. Doing so might shorten the life of the lamp.
- Disconnect the power cord from the power outlet if you are not going to use the projector for a long period of time.
- Allow at least about ten seconds before reconnecting the power supply after disconnecting the power cord.

NOTE

- Due to its characteristics, the lamp may not light if it is turned on immediately after it is turned off. Wait for at least one minute before turning it on again.
- The lamp may emit a slight humming noise when it is turned on. This is not a malfunction.

Basic Operations in the OHP Mode

The functions described here can be operated only when OHP input is selected.

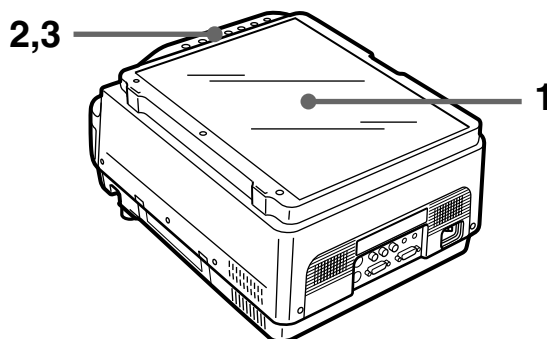

NOTE

- The projected image in the OHP display (projection of actual object) may be slightly distorted as a very wide-angle lens is used.

1

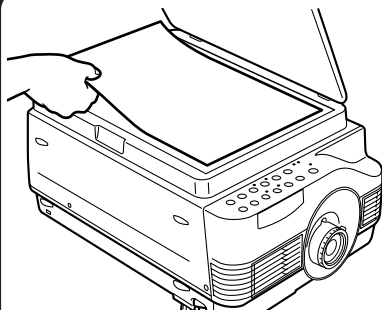

Place the object you want to project.

Open the document cover, and place the document or printed matter you want to project on the document pickup section.



Close the document cover.

NOTE

- Objects can be projected even if the document cover is not closed. However, unwanted objects will also be picked up, making the projected image difficult to view.

2

Main Unit Operation

ZOOM



Remote Control Operation



Adjust the zoom ratio.

You can adjust the zoom between 1x to 2x.

Pressing the button on the left reduces the image, and pressing the button on the right enlarges the image.

3

Remote Control Operation

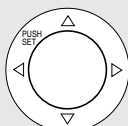

Move the zooming position.

Press the arrow buttons on the remote controller to move the zooming position of the image.

- △ Button: Moves the position up.
- ▽ Button: Moves the position down.
- ◀ Button: Moves the position to the left.
- ▶ Button: Moves the position to the right.

4

Main Unit Operation

BRIGHTNESS



Remote Control Operation



NOTE

- When projecting dark documents or printed matter, adjust to lighten the screen, and when projecting bright documents or printed matter, adjust to darken the screen.

Adjust the brightness.

Pressing the button on the left darkens the screen, and pressing the button on the right lightens the screen.

When the projected image is frozen, brightness cannot be adjusted. Cancel freeze to adjust the brightness.

5

Main Unit Operation

● FREEZE



Remote Control Operation



Freeze the screen.

Each press of the FREEZE button freezes the projected screen or cancels a frozen screen. When the FREEZE button is used, the projected image will stay fixed at the same location even if the document is moved.

When images are frozen, the FREEZE LED lights (green).

When images are frozen, zoom, moving of the zooming position, and keystone compensation are possible. Brightness, however, cannot be compensated.

6

Remote Control Operation



Switch to portrait display.

The output screen is switched to the portrait display mode by turning the PORTRAIT button ON when projecting portrait documents.

The left and right scroll buttons can be operated only when the left and right sides of the image on the display are clipped when the zoom ratio has been adjusted.

7

Remote Control Operation



Compensate the keystone.

See "Compensating Keystone" on page 33.

Document Orientation and Pickup Size

Place the document or printed matter face down at the orientation shown in the figure below.

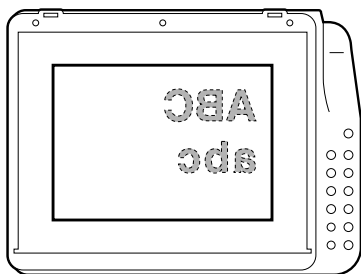

The maximum size that documents or printed matter can be picked up is 216 mm/8.5 in (vertical) and 288 mm/11.3 in (horizontal). For this reason, the projected sizes are as follows when an A4-size sheet of paper is placed at the respective orientations. (Shaded section is the projected area.)

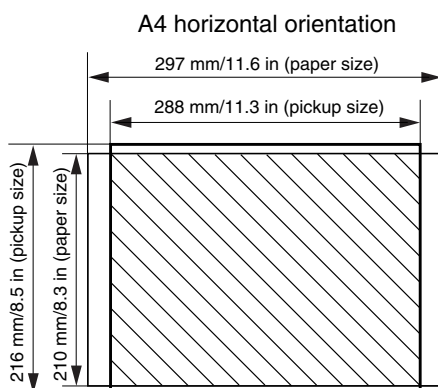

Parts protruding outside the pickup area are not projected on the screen. To project these parts, move the paper.

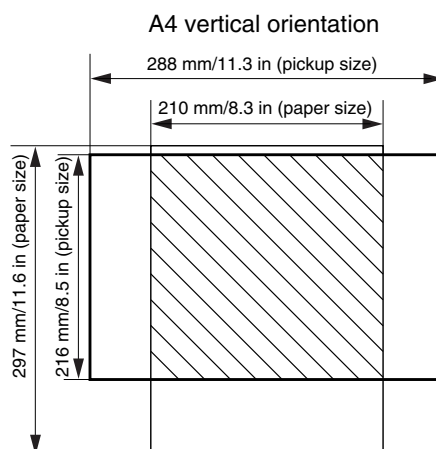

When placing A4-size paper vertically, the screen can be effectively used by enlarging the zooming ratio.

Attaching the Positioning Plate

Attach the positioning plate in the direction shown below.

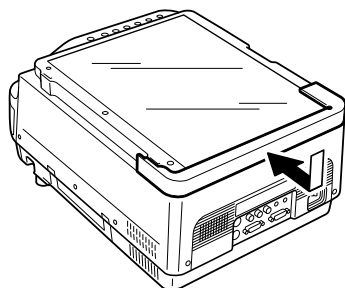

Documents can be easily centered by aligning them with the positioning plate when placing them on the pickup section.

■ PC Zoom

The functions described here can be operated only when PC input is selected.
The zoom function can be operated on the remote controller.

1

Main Unit Operation

● VIDEO ● PC

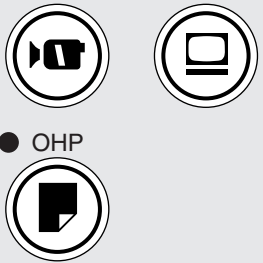

● OHP

Remote Control Operation

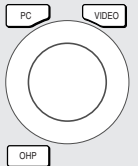

Select the input.
Select PC (personal computer) as the video source to be displayed. The PC input image is displayed.

* You can select the input on either the main unit or the remote controller.

2

Remote Control Operation



Select the zoom ratio.
Select the zoom (enlargement ratio) by the ZOOM button on the remote controller.
Pressing the (+) button enlarges the image up to 4x.
Pressing the (-) button reduces the image down to 1x.

* You can select any zoom ratio (enlargement ratio) up to 4x.

3

Remote Control Operation

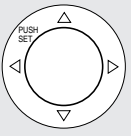

Move the zooming position.
Press the arrow buttons on the remote controller to move the zooming position of the image.

- △ Button: Moves the position up.
- ▽ Button: Moves the position down.
- ◁ Button: Moves the position to the left.
- ▷ Button: Moves the position to the right.

* Blank areas may appear at the top, bottom, left or right in the PC signals that are input to the projector on the zoom display area.

■ Compensating Keystone

When keystone compensation is performed, the resolution at the top (or bottom) of the screen is reduced, making small characters harder to read. To prevent this, place the projector on as level a table as possible, and set “Keystone” in the “Setting” menu to “0”. (For details of how to set this, see “Performing Various Adjustments” on page 34.)

● How to Compensate Keystone

Example 1

Press the  KEYSTONE button on the remote controller to reduce the width at the bottom of the screen.

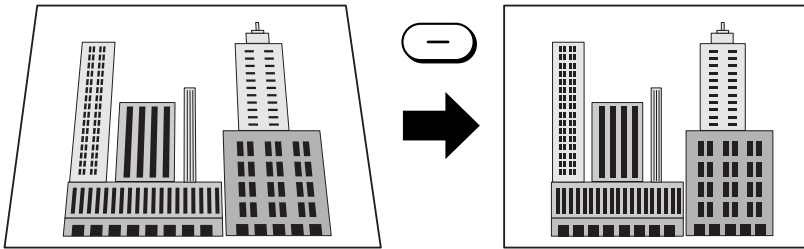

Example 2

Press the  KEYSTONE button on the remote controller to reduce the width at the top of the screen.

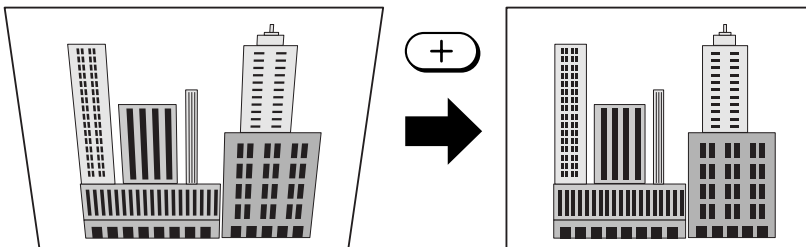

NOTE

- As image processing is performed for keystone compensation, displayed images (characters, etc.) are displayed slightly blurred when keystone compensation is used compared with when it is not used.

■ Performing Various Adjustments

Menu Structure

You can perform various adjustments and make various settings by operating the buttons with the menu screen displayed on the projection screen. To display the main menu screen, connect the PC or video deck, and press the  button (or  button) with the PC or video deck turned on. Move to the required menu from the main menu screen.

The figure below shows how to move between the main and menu screens. (When OHP is selected as the input, the menus are displayed even if the PC or video deck is not connected. When PC or VIDEO is selected, the menu will not be displayed unless there is an input signal.)

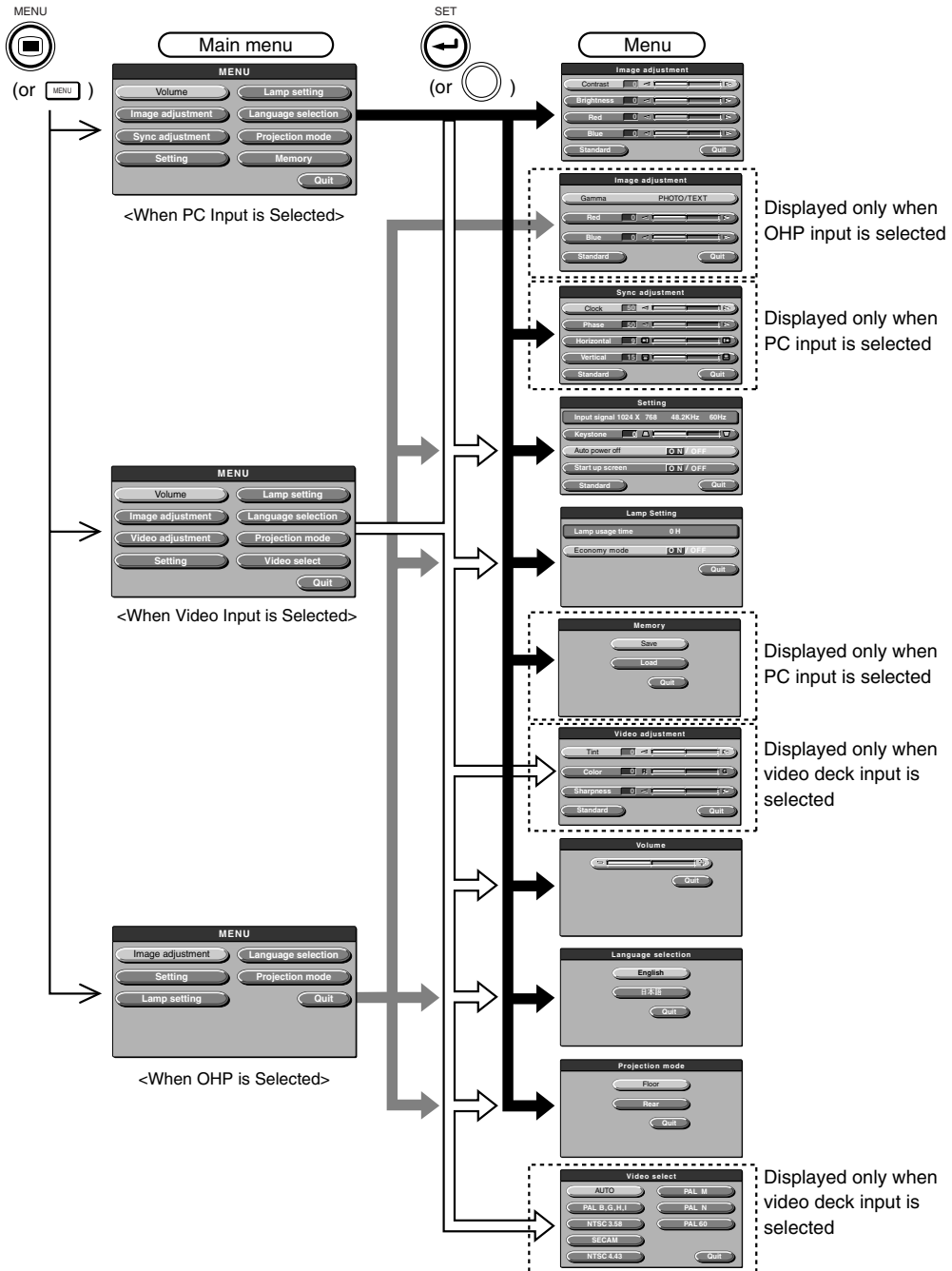

Description of Menu Items

The following describes each of the menu screens, and the items and functions that can be set in these menu screens. For details of how to set these menu items, see “Basic Operation” on page 38.

◆ Image Adjustment (when PC input or video deck input are selected)

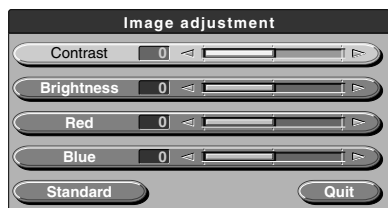

<Image Adjustment Menu>

Menu Item	Setting Item	Description
Contrast	-100 ~ +100	Adjusts the contrast of the screen.
Brightness	-100 ~ +100	Adjusts the brightness of the screen.
Red	-100 ~ +100	Adjusts the shade of the color red.
Blue	-100 ~ +100	Adjusts the shade of the color blue.

◆ Image Adjustment (when OHP is selected)

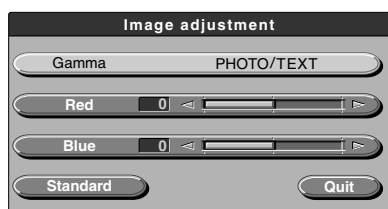

<Image Adjustment Menu>

Menu Item	Setting Item	Description
Gamma	PHOTO/TEXT	The TEXT setting compensates for text documents, and the PHOTO setting compensates for photo documents. Select the setting to suit the document you are projecting.
Red	-100 ~ +100	Adjusts the shade of the color red.
Blue	-100 ~ +100	Adjusts the shade of the color blue.

◆ Sync Adjustment (only when PC input is selected)

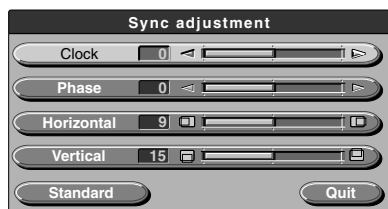

<Sync Adjustment Menu>

Menu Item	Setting Item	Description
Clock	-100 ~ +100	Adjusts the horizontal size of the image.
Phase	-100 ~ +100	Adjusts noise and flickering.
Horizontal	-100 ~ +100	Adjusts the horizontal position of the image.
Vertical	-100 ~ +100	Adjusts the vertical position of the image.

NOTE

- Menu items sometimes cannot be adjusted within the range -100 to +100 depending on the PC input signal.

◆ Setting

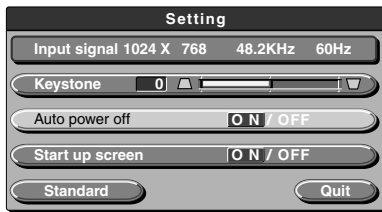

<Setting Menu>

Menu Item	Setting Item	Description
Keystone	-100 ~ +100	Compensates the keystone of the image.
Auto power off	ON/OFF	Sets the auto power off function ON/OFF. When auto power off is set to ON, the projector automatically enters the standby mode if no signals are input for a fixed period of time (about 15 minutes).
Startup screen	ON/OFF	Sets whether or not to display the logo while the lamp is lit.

NOTE

- In the "Setting" menu, the currently set input signals can be displayed for confirmation.

◆ Lamp Setting

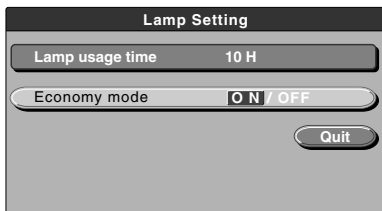

<Lamp Setting Menu>

Menu Item	Setting Item	Description
Economy mode	ON/OFF	Sets the lamp economy mode.

- * When the lamp economy mode is set to "ON", lamp brightness is reduced slightly, and the power consumption is reduced. The rotating noise of the fan is also reduced at the same time.

NOTE

- In the "Lamp setting" menu, the current accumulated usage time of the lamp can be displayed for confirmation.

◆ Video Adjustment (only when video deck input is selected)

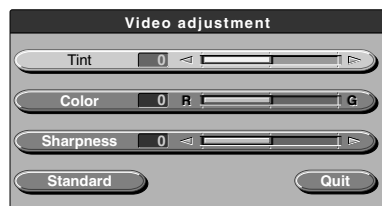

<Video Adjustment Menu>

Menu Item	Setting Item	Description
Tint	-100 ~ +100	Adjusts the tint of projected images.
Color	-100 ~ +100	Adjusts the color of projected images.
Sharpness	0 ~ 6	Adjusts image sharpness.

◆ Memory (only when PC input and video deck input is selected)

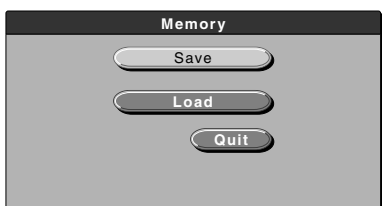

<Memory Menu>

Menu Item	Setting Item	Description
Save	—	Saves the details set in the Sync Adjustment menu.
Load	—	Loads saved details.

◆ Volume (only when PC input and video deck input is selected)

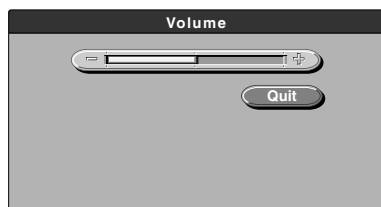

<Volume Menu>

Menu Item	Setting Item	Description
Volume	—	Adjusts the volume.

◆ Language Selection



<Language Selection Menu>

Menu Item	Setting Item	Description
Language selection	English	Sets the language of the menu display.
	Japanese	

◆ Projection Mode

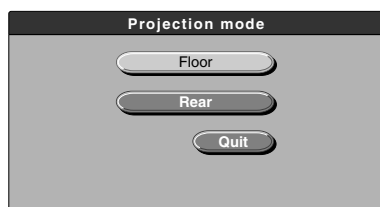

<Projection Mode Menu>

Menu Item	Setting Item	Description
Projection mode	Standard	Adjusts the projection mode according to the installation method (front (standard) projection or rear projection).
	Rear	

◆ Video Select (only when video deck input is selected)

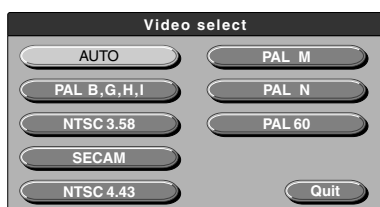

<Video Select Menu>

Menu Item	Setting Item	Description
Video select	AUTO	Selects the input signal type.
	PAL B,G,H,I	
	NTSC3.58	
	SECAM	
	NTSC4.43	
	PAL M	
	PAL N	
	PAL 60	

Basic Operation

The following describes basic operations in the following menus: “Image Adjustment”, “Sync Adjustment”, “Setting”, “Lamp Setting”, “Volume”, “Language Selection”, “Video Adjustment”, “Projection Mode”, and “Video Select” with the exception of “Memory”, which is described on page 42.

Main Unit Operation

1,2

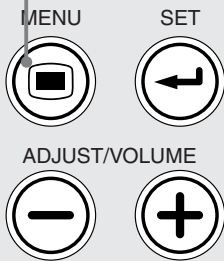

Remote Control Operation

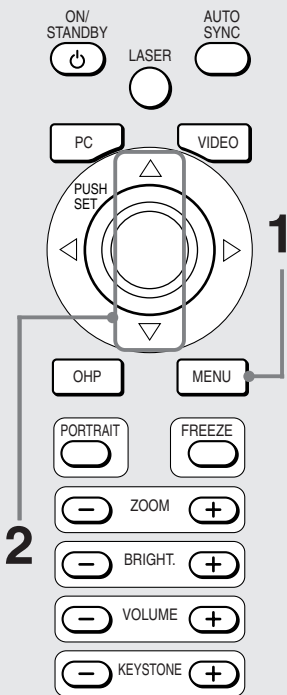

- 1** Press the  button (or the  button).

The main menu is displayed.

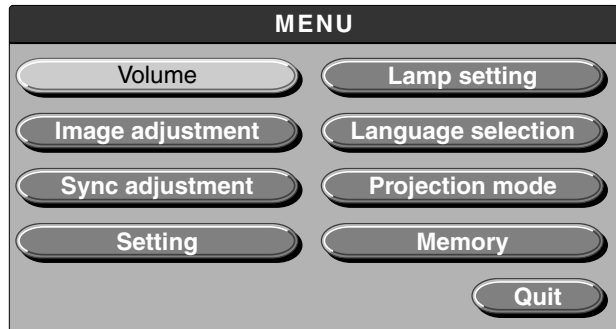

<Example: When PC input is selected>

- 2** Press the  button (or Δ / ∇ buttons) to select the item you want to set.

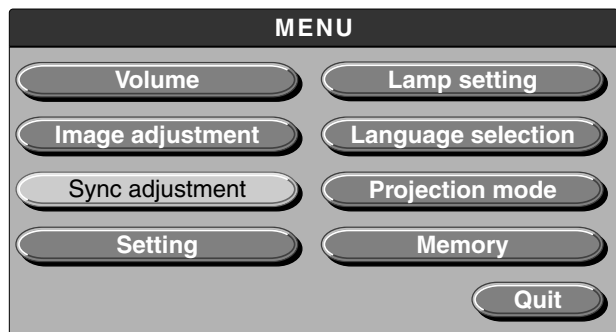

<Example: When “Sync adjustment” is selected>

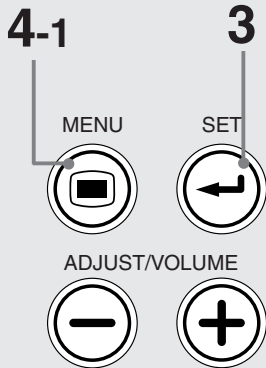

Main Unit Operation

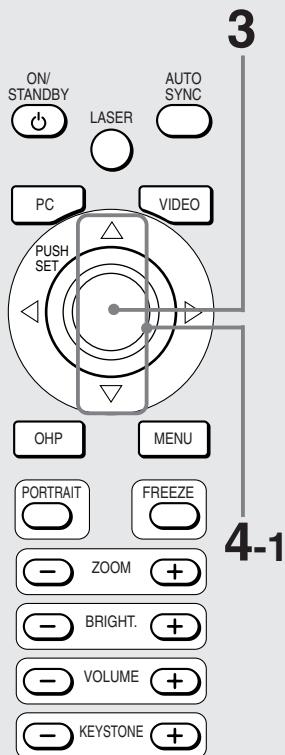

Remote Control Operation



3 Press the button (or the button).

The menu screen for the item you want to set is displayed. To return to the initial settings when you bought the projector, select "Standard" and press the  button (or  button) in the "Image adjustment", "Sync adjustment", "Setting" or "Video adjustment" menus.

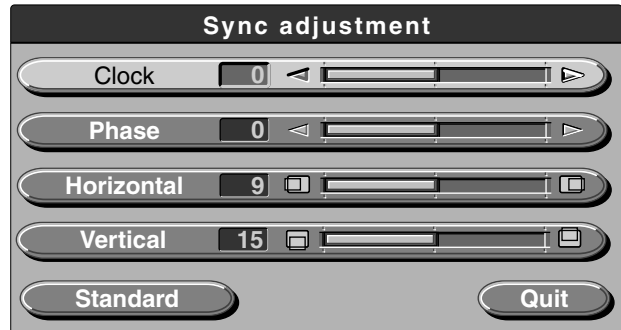

<Example: Sync Adjustment Menu>

When selecting "ON" or "OFF".

Menu items that require selection of "ON" or "OFF" are "Auto power off", "Start up screen" and "Economy mode". For details of these menu items, see page 35.

4-1 Press the button (or / buttons) to select the item you want to set.

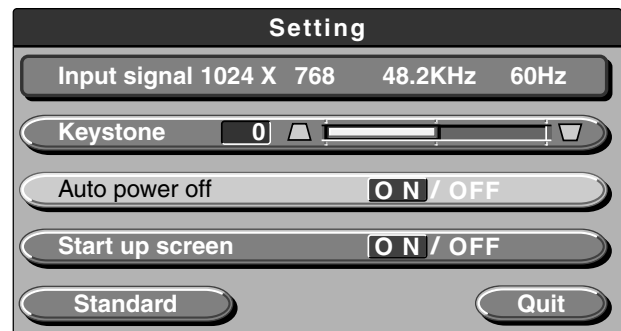

<Example: When "Auto power off" is selected>

Main Unit Operation

4-1

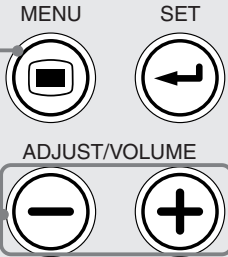

4-2

Remote Control Operation

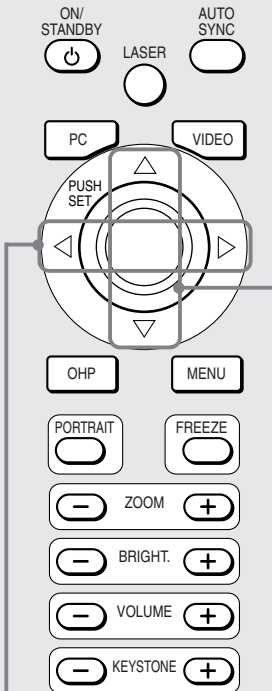

4-2

4-1

4-2

Press the \ominus / \oplus buttons (or \triangleleft / \triangleright buttons) to select “ON” or “OFF”.

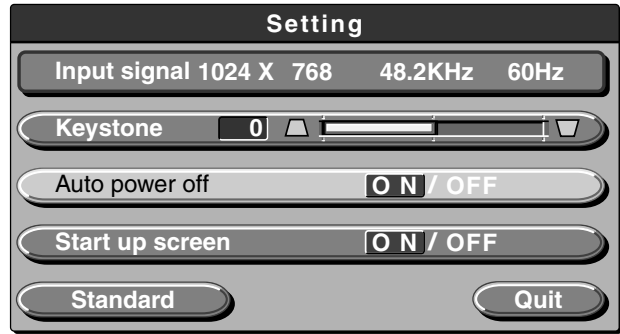

When adjusting in single point units

Menu items that require adjustment in single point units are “Contrast”, “Red”, “Blue”, “Clock”, “Phase”, “Horizontal”, “Vertical”, “Keystone”, “Tint”, “Color”, “Sharpness”, and “Volume”. For details of these menu items, see page 35.

4-1

Press the MENU button (or \triangle / ∇ buttons) to select the item you want to set, and press the \triangle button or ∇ button.

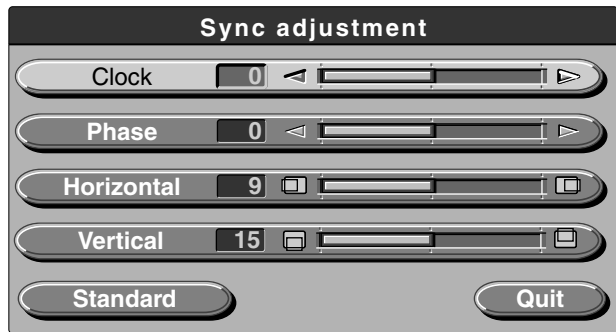

<Example: When “Clock” is selected>

Main Unit Operation

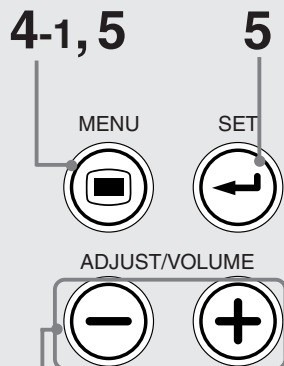

4-2

Remote Control Operation

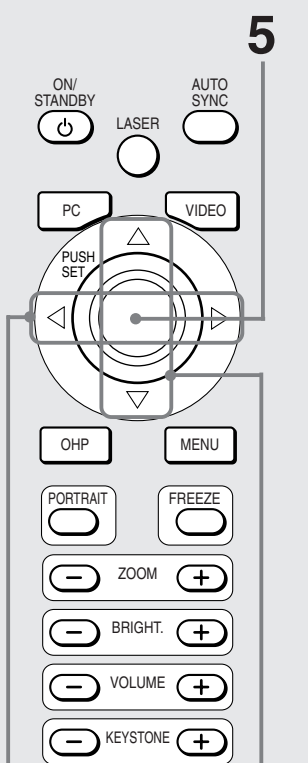

4-2

4-1, 5

4-2 Press the \ominus / \oplus buttons (or \triangleleft / \triangleright buttons) to adjust the setting.

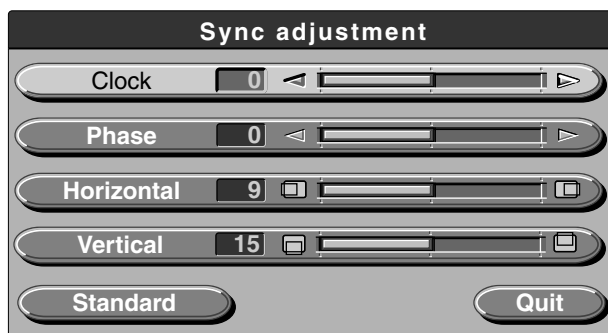

Others

Other menu items include “Language selection”, “Projection mode” and “Video select”. For details of menu items, see page 35.

4-1 Press the MENU button (or \triangle / ∇ buttons) to select the item you want to set, and press the SET button (or ENTER button).



<Example: When “English” is selected from the “Language Selection” menu>

5 Press the MENU button (or \triangle / ∇ buttons) to select “Quit” and then press the SET button (or ENTER button).

This returns the display to the main menu. The display automatically disappears, and adjustment values are stored to memory if buttons are not operated for about 15 seconds.

■ About the Memory Menu

If you have made adjustments to the size of an image, noise or flicker, or the horizontal and vertical positions when you have selected PC input, the details of these settings can be saved to memory. You can also call up details of setups that you have saved. When you first buy your projector, nothing is set to these memory items.

● How to Save

1 Adjust the image display in the Sync Adjustment menu (page 35).

2 Select "Memory" in the main menu.



3 Select "Save".

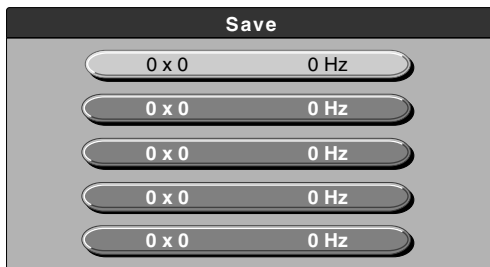

Press the  button (or Δ / ∇ buttons) to select the item to save. You can register up to five items you want to save to memory.

The message "Save?" is displayed as shown below. If you select "YES", the item is saved and the menu automatically disappears.

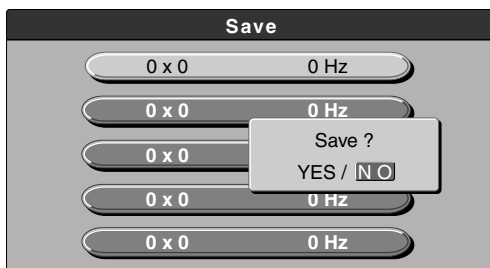

If you select "NO", the menu automatically disappears.

● How to Load Saved Settings

1 Select "Memory" in the main menu.

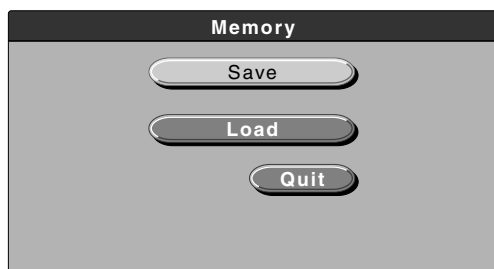

2 Select "Load".

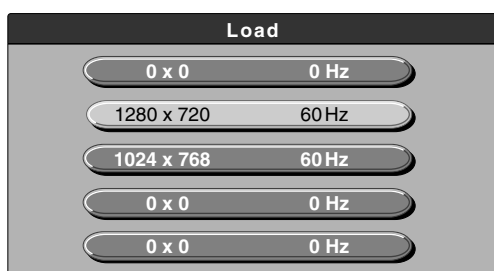

Press the  button (or Δ / ∇ buttons) to select the data to be loaded. Select an item to which saved data is registered.

The message "Load?" is displayed as shown below. If you select "YES", the item is loaded and the menu automatically disappears.

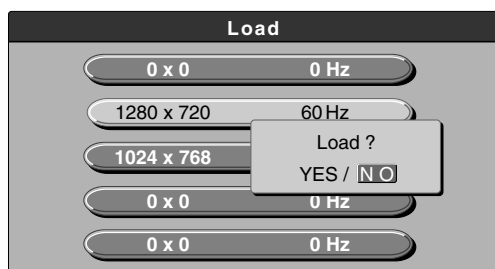

If you select "NO", the menu automatically disappears.

NOTE

- Even if selected, the selected channel is canceled, and signal identification is switched to automatic extraction when the input signal changes.

Maintenance

■ Protection Against Overheating

Your projector is provided with internal protection circuits for preventing fire and damage to internal components due to abnormal temperature.

When the power indicator LED is blinking:

● Action

1. Unplug the power plug from the power outlet.
2. Check the air filter for dirt.
 - * If the LAMP LED also is blinking at the same time, replace the lamp.
For details of how to replace the lamp, see page 46.

When the ALARM LED is lit:

● Action

1. Unplug the power plug from the power outlet.
2. Check the following and take corrective actions.

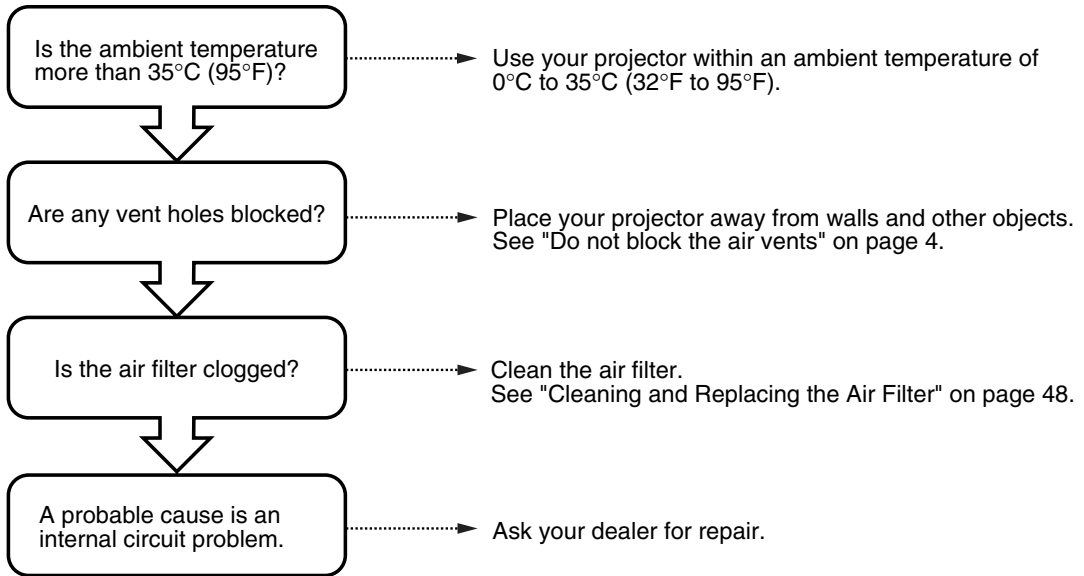

* When the ALARM LED is OFF, your projector is working properly.

● When the power fails (all LEDs are off with the power ON)

○ Action

1. Unplug the power plug from the power outlet.
2. Check the following and take corrective actions.

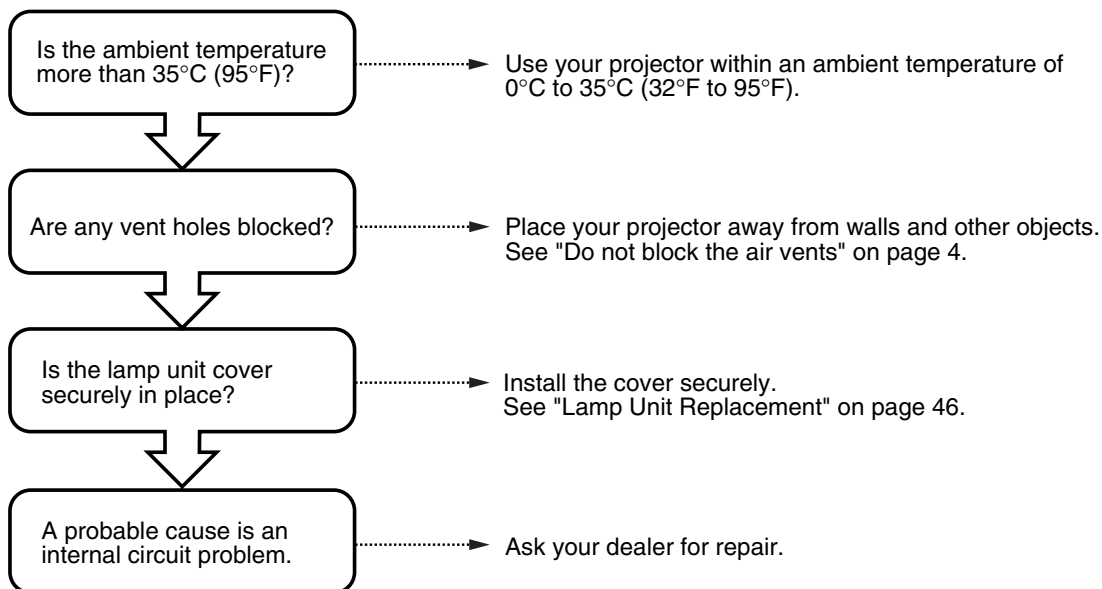

■ Lamp Unit Replacement

The target replacement time of the lamp used on this projector is 950 hours. (This may be shortened depending on the conditions of use.)

Since there is a high possibility of lamp explosion if the cumulative usage time exceeds more than 1000 hours, the power to the lamp is cut off at 1000 hours.

In the following instances where the cumulative usage time of the lamp is more than 950 hours, replace the lamp unit (sold separately). When the projected image becomes dark or projected colors are unsatisfactory, the lamp has reached the end of its life. In this case, replace the lamp unit.

- When the message shown below is displayed while the lamp is lit (This appears when the cumulative usage time of the lamp is more than 950 hours.)

Lamp usage 950 hours.
Replace the lamp.

- When "Lamp usage time" on the menu display screen has reached 950 hours, the LAMP LED blinks.
The lamp usage time is displayed in the "Lamp setting" menu for confirmation. (For details, see page 36.)
- When the LAMP LED is lit without the lamp lighting.
(When the cumulative usage time of the lamp is more than 1000 hours.)

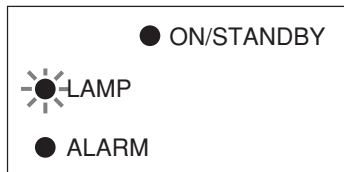

⚠ WARNING

- Do not replace the lamp unit immediately after you have turned the projector off. The lamp becomes very hot and may cause a burn injury. Turn off the lamp, unplug the plug from the power outlet, and then wait at least one hour before replacing the lamp.
- Do not touch the lamp with your hands. This may result in reduced brightness or reduced lamp life.
- This projector contains many glass components (e.g. a lamp and mirrors). If these glass components break, handle them with care to prevent personal injury from glass fragments. Contact your dealer or a Nippon Avionics service center for repair.

⚠ CAUTION

- This lamp unit is not compatible with the lamp unit for the MP-100, MP-150, MP-200, MP-250, MP-300, and MP-400. Specify the exclusive lamp unit (model No.: MPLU-10).

Procedure

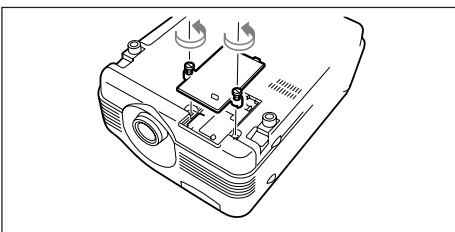

1 Remove the lamp unit cover.

Loosen the lamp unit cover screws (2 pieces) using a regular screwdriver.

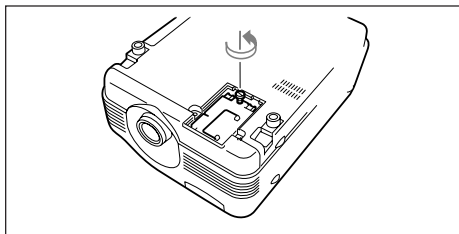

2 Loosen the lamp unit retaining screw.

Loosen the lamp unit screw. (1 piece)

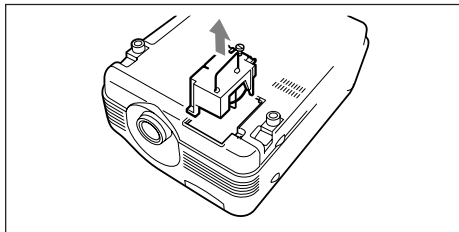

3 Draw out the lamp unit.

Hold the handle and lift the lamp unit upward.

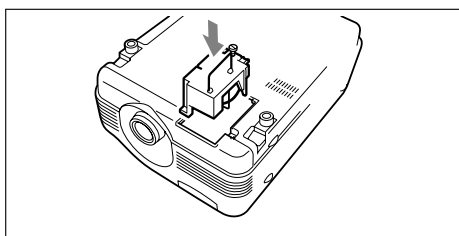

4 Install a new lamp unit.

- ① Hold the lamp unit and push it in.
- ② Tighten the lamp unit retaining screw.
- ③ Turn down the handle of the lamp unit.
- ④ Install the lamp unit cover, and tighten the two retaining screws.

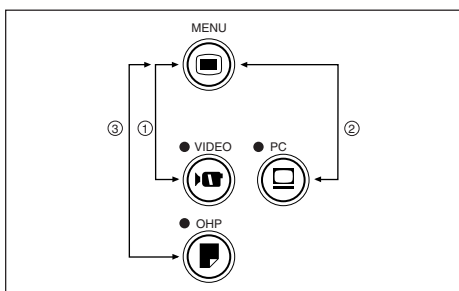

5 Reset the lamp usage time.

Perform the following in the standby state.

Press the , and buttons once in that order with the button held down.

The LAMP LED then blinks.

CAUTION

Do not reset the lamp usage time without replacing the lamp. The probability of a lamp explosion increases if the cumulative usage time of the lamp is more than 1000 hours.

6 Verify that the display of lamp usage time in the Lamp Setting menu is "0H" as shown to the left.

If the lamp usage time is not reset, reset it by repeating step 5.

CAUTION

Be sure to reset the lamp usage time after replacing the lamp. Otherwise, the correct usage time cannot be known. When the display exceeds 1000 hours, the power to the lamp is forcibly turned off regardless of the lamp's life.

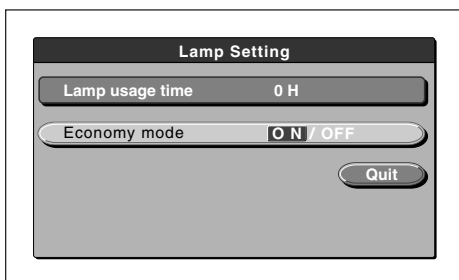

NOTE

- As a safety precaution, your projector does not turn on unless the lamp unit cover is installed.
- The lamp unit sold separately comes with an air filter as part of the lamp kit. When replacing the lamp unit, be sure to replace the air filter as well. (See page 48.)

■ Cleaning the Air Filter

The air filter is an important part as it keeps the optical components inside your projector free from dirt and dust. A clogged air filter can cause the temperature to rise inside your projector and the fan speed to increase. This, in turn, may reduce lamp life or cause the projector to malfunction. The air filter should be cleaned regularly (about once a month if the projector is used four hours a day).

Replace with a new air filter if it is difficult to remove dust and dirt from the air filter.

Procedure

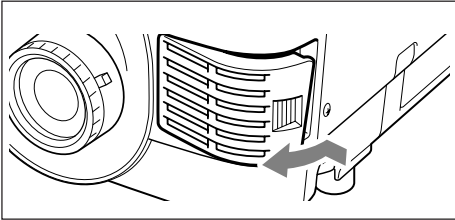

1 Remove the air filter.

Pull the air filter in the direction of the arrow while pressing in the indent to remove.

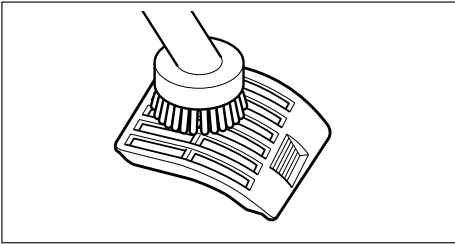

2 Vacuum the sponge to take off dust.

Vacuum the outside surface of the sponge as shown in the illustration.

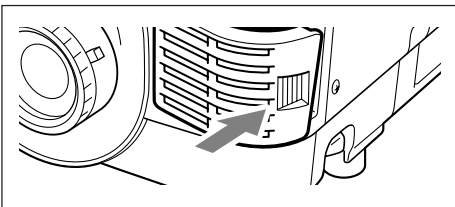

3 Mount the air filter.

Follow step 1 in reverse order.

⚠ CAUTION

Caring for the Air Filter and Cautions

- Do not wash the air filter with water or other liquids. This may cause the filter to clog.
- Do not wipe the air filter with a cloth or a wet rag as this, too, may cause the filter to clog.
- Always vacuum from the outside of the air filter. If you vacuum from the inside of the air filter, this will reduce the effectiveness of the air filter.
- Do not forget to install the air filter. If the projector is left without the air filter installed, dust may enter the projector and cause dirty projected images.
- When the air filter becomes damaged, be sure to replace with a new one. If the projector is used with the air filter damaged, dust may enter the projector and cause dirty projected images.

NOTE

The lamp will not light unless the air filter is mounted.

Troubleshooting

If you think a problem has occurred, check the following items before asking for a repair.

Symptom	To be Checked	Page(s)
Power is not on.	• Verify that the power cord is plugged in.	18
	• Verify that the lamp unit cover is installed.	46
The projection lamp does not light.	• Verify that the lamp has not blown.	46
	• Verify that the air filter is installed.	48
	• Verify the internal temperature. The lamp does not light due to a protection control if the temperature is too high.	44
	• Verify that the lamp usage time is less than 1000 hours.	46
No image is displayed.	• Verify the selection of the connected input.	26
	• Verify that the cable for the connected device is appropriately connected.	19, 25
	• Verify sure that Brightness or Contrast in the Image Adjustment menu is not set to minimum.	35
	• Verify that the resolution on the PC is correctly set.	21
	• Verify the functions of the PC.	21
The image is distorted.	• Verify that the projector is placed properly.	18
	• Keystone compensation may be applied.	33
The image is blurred.	• Check the focus.	27
	• Make sure that the projection distance is within the focusing distance.	17
	• Keystone compensation may be applied.	33
The image is flickering.	• Adjust Phase in the Sync Adjustment menu.	35
	• Perform the automatic sync adjustment by pressing the AUTO SYNC button.	14
The image is out of alignment.	• Check the setting of the Sync Adjustment menu.	35
The color is out of alignment.	• Adjust Phase in the Sync Adjustment menu.	35
No sound.	• Make sure that the setting in the Volume menu is not set to minimum.	37
The cabinet produces a cracking sound.	• A sound is produced when the cabinet slightly expands or contracts due to the changes in the room temperature. This will not affect projector performance.	—
The ALARM LED lights up or blinks.	• Follow the procedures for protection against overheating.	44
	• Make sure that the air filter is not dirty.	48
The LAMP LED blinks (red).	• Make sure that the lamp usage time is not more than 950 hours.	46
The power indicator LED blinks.	• Make sure that the air filter is not disconnected.	48
The remote controller does not work.	• Make sure that the battery is not blown or worn.	15
	• Make sure that other light from lighting, for example, is not entering the remote control sensor.	9, 10
	• Make sure that the remote control sensor of the main unit is not obstructed.	9, 10
	• Make sure that the projector is not installed near inverter-driven equipment.	15

Limited Warranty & Warranty Service

LIMITED WARRANTY PERIOD

- The Limited Warranty is valid for one year from the date of purchase. This Limited Warranty does not cover consumable parts such as lamp and air filter.
- Some repairs are chargeable to the user even within the effective Limited Warranty period.
- For details of repairs after the Limited Warranty period has elapsed, consult your dealer. Repairs can be performed at cost to the user if the functions of the product can be maintained.

WARRANTY SERVICE PROCEDURE

- Before asking for service, check the Troubleshooting section once again. If, as a result of this check, you think that a fault has developed, contact the dealer from whom you purchased the product.
- When asking for service, provide your dealer with the following information:
 - Description of trouble (in as much detail as possible)
 - Date of purchase
 - Name
 - Address
 - Telephone number
 - Product name and model No. (written on label on rear of multi projector)

Specifications

Mode Name			MP-15E
Type			3 primary Color LCD Shutter Projection Type
Main Part Specification	LCD Panel	Size	0.9 inches x 3 Panels, Aspect Ratio 4:3
		Drive System	Poly Silicon TFT Active Matrix
		Number of Pixels	786,432 pixels (1,024 x 768 dots) x 3
		Arrangement	Stripe
	Projection Lens		Manual Zoom: 1 to 1.2x, f=36 mm to 43.2 mm, F2.2 to 2.6
Optical Source		150 W	
Display Size			25 inches to 252 inches (projection distance 1.15 to 10 m)
Color Reproducibility			Full color (16,770,000 colors)
Brightness			1100 ANSI lumens (at normally white)
Scan Frequency			Horizontal 15 to 80 kHz, Vertical 50 to 75 Hz
Maximum Resolution (at RGB signal input)			1,024 x 768 dots (Compressed display of 1,280 x 1,024 dots is possible.)
Video Input/Output	OHP (actual object projection section)	Pickup unit	1/2 inch CCD camera (2 million pixels)
		Pickup speed	4 frames/sec
		Pickup size	At 1x: 288 mm x 216 mm (11.3 in x 8.5 in), At 2x: 144 x 108 mm (5.7 in x 4.2 in)
	PC (Analog RGB Input)	Signal system	Separate Signal System
		Video signal	Analog: 0.7Vp-p/75Ω
		Sync Signal	Separate/composite: TTL Level (positive/negative)
		Input/Output Terminals	15 pin Mini D-sub 1 ch
	Video	Connection Cable	Various cables for Macintosh, VGA (cables other than for VGA are sold separately)
		Signal system	NTSC/PAL/SECAM
	Monitor Output	Input Terminal	RCA Pin Terminal 1 ch, S terminal 1 ch (Mini DIN4-pin) x 1
		Video signal	0.7Vp-p/75Ω
		Sync Signal	Separate TTL Level, Minus Polarity
	Audio input	PC, Video	Output Terminal
Audio Signal			0.4Vrms/47KΩ
Monitor Output		Input Terminal	RCA Pin Jack
		Audio Signal	0.4Vrms/47KΩ ^{※1}
Output Terminal		Stereo Mini Jack	
Audio Output			1.5 W x 2 stereo
Operating Range of Temperature and Humidity			Temperature: 0 to 35°C (32 to 95°F), humidity: 20 to 80% (no condensation)
Power Source			100-120/220-240V AC 50/60 Hz
Power Consumption			250 W (during standby: approx. 7 W)
External Dimensions (mm/in)			298 (W) x 398 (D) x 189.5 (H) /11.7 (W) x 15.6 (D) x 7.4 (H) (including document cover)
Weight			5.4 kg (12 lb) (including document cover)
Accessories			Power Cord (3 m/3.3 yd), Remote Control, Positioning Plate, User's Manual, Battery (AAA x 2), MPC-VGA Cable

※ 1 : Input signals, which are synchronized with the selected screen, are provided for output.

● Specifications and designs are subject to change without prior notice in order to improve the product.

NIPPON AVIONICS CO.,LTD.
Head office : 3-20-1 Nishi Shinbashi, Minato-ku, Tokyo

Technical Support Information

Instrument Service Center, Electronics Equipment Division
2-28-2 Hongo, Seya-ku, Yokohama
Zip code : 246-0015
Tel : 81-45-304-8233

To customers : Enter the name and date of the store where you purchased this product. This information will be useful when you ask your dealer for repair.

• Date of Purchase (year, month, day)

• Store of Purchase

Telephone Number : ()